

# **SMARTRing<sup>®</sup> Ordering Guide**

**Wholesale Business Markets**

**Copyright**

March 24, 2005-December 11, 2006

© BellSouth Telecommunications

# Contents

Subject	Page
<b>Introduction / Revision History</b> .....	<b>1</b>
Purpose .....	1
Version Information .....	1
<b>1. WEBSITE Addresses</b> .....	<b>2</b>
1.1 BellSouth Ordering Guides .....	2
1.2 Tariff Reference .....	2
1.3 Technical Reference .....	2
<b>2. SMARTRing Service</b> .....	<b>3</b>
2.1 Overview .....	3
2.2 General Description- SMARTRing Service .....	3
<b>3. Service and Feature Description</b> .....	<b>5</b>
3.1 Service Description .....	5
3.2 Optional Features .....	5
3.3 Service Availability .....	5
<b>4. Service Level Agreements</b> .....	<b>6</b>
4.1 Quality Performance Objectives .....	6
4.2 Dedicated Ring Service DS3/STS-1 Quality Performance Objectives .....	6
4.3 Annual Service Availability .....	6
4.4 Service Continuity .....	6
4.5 Credit for Service Outages .....	6
<b>5. Network Interfaces</b> .....	<b>8</b>
5.1 SMARTRing Interface Elements .....	8
5.2 Asymmetrical Interfaces .....	8
5.3 SMARTRing Asymmetrical Interface Combinations .....	9
5.4 SMARTRing Level Elements .....	20
5.5 SMARTRing Rate Elements Defined .....	20
5.6 SMARTRing Flexible DS1 Interface .....	21
5.6.1 Flexible DS1 Interface.....	22
5.7 Flexible DS1 Interface Restrictions .....	22
5.8 SMARTRing Service- 10/100 Mb and Incremental/Fractional ETHERNET for OC12/OC48/OC192 .....	23
5.9 Service Overview .....	23
5.10 Service Design .....	23
5.11 ETHERNET Interfaces .....	23
5.12 SMARTRing Channel Availability .....	24
<b>6. Charges</b> .....	<b>25</b>
6.1 Cancellation Charges .....	25
<b>7. Restrictions</b> .....	<b>26</b>
7.1 Restrictions .....	26

<b>8.</b>	<b>FCC Tariff Payment Plans .....</b>	<b>27</b>
8.1	Transport Payment Plan (TPP) .....	27
8.2	Minimum Bill Requirements .....	27
<b>9.</b>	<b>Service Inquiry .....</b>	<b>28</b>
9.1	Service Inquiry Requirements .....	28
9.2	Due Date Intervals .....	28
<b>10.</b>	<b>Site Preparation .....</b>	<b>29</b>
10.1	BICS Form Requirements .....	29
<b>11.</b>	<b>Service Order Elements .....</b>	<b>30</b>
11.1	Service Order Requirements .....	30
11.2	SNID (SONET Network Identification) .....	30
11.2.1	SONET Network ID Format.....	30
11.3	Connecting Facility Assignment .....	31
11.4	Transmission Path for the Ring (ID's) .....	31
11.5	Billing Account Number .....	31
11.6	Service Related Field Identifiers (FIDs) .....	32
<b>12.</b>	<b>ASR Requirements .....</b>	<b>33</b>
12.1	ASR Requirements .....	33
12.2	Access Service Request Screen (ASR) .....	33
12.3	Administrative Screen (ADM) .....	36
12.4	ASR-Bill Section .....	36
12.5	VTA- Variable Term Agreement .....	36
12.6	ASR- Contact Section .....	37
12.7	ASR Transport Screen (SPE/SP2) .....	38
12.7.1	Network Channel (NC) Code Definition.....	41
12.7.1.1	Network Channel (NC) Codes.....	41
12.7.2	Network Channel Interface (NCI) Code Definition.....	44
12.7.2.1	NCI Codes.....	44
<b>13.</b>	<b>USOCS- Universal Service Order Codes .....</b>	<b>45</b>
13.1	Class of Service .....	45
13.2	Rate Elements USOCS .....	45
13.3	Central Office Nodes .....	45
13.4	Customer Premise Channel Interface .....	46
13.5	Local Channel (LC) .....	46
13.6	Alternate Central Office Channel (ACOC) .....	47
13.7	Internodal Channel (INCH)- Same Serving Wire Center .....	47
13.8	Internodal Channel (INCH)- Contiguous Serving Wire Center .....	47
13.9	Interoffice Channel (IOC) .....	47
<b>14.</b>	<b>Service Activations .....</b>	<b>48</b>
14.1	STS-1 Point-to-Point Activation .....	48
14.2	Optical Point to Point Activation .....	50
14.3	DS3 Activation .....	51
14.4	DS1 Activation .....	54
<b>15.</b>	<b>Acronyms .....</b>	<b>57</b>
15.1	Acronym Definition .....	57

Appendix A. SMARTRing Asymmetrical Interfaces..... 59

## Acronyms

BICS

Building Industry Consultant

## Introduction / Revision History

### Purpose

This ordering guideline is intended to provide Product Descriptions and General Ordering Information that is unique and specific to the BellSouth SMARTRing service, which is supported by the BellSouth Federal Communications Commission (FCC)#1 Access Tariff.

**NOTE: This is not a complete ordering guideline for SMARTRing Service.**

### Disclaimer

The information contained in this ordering guideline is subject to change. BellSouth will provide notification of changes through the Carrier Notification Process.

### Version Information

Updated Contact Information

**TABLE A. Revision History**

Chapter	Action Request #	Date / Issue	Description	Change Requested By / Made By
Introduction	N/A	December 11, 2006/ 2a	Updated contact information	Jim Cuckler / Jason Parson / M. Laney
Site Preparation	N/A	February 22, 2006 / 2	Added new section and BICS information	Randy Ray/ Jason Parson
Transport Payment Plan, VTA- Variable Term Agreement	17271	September 19, 2005 /1a	Updated information related to changes in the TPP arrangement.	Terry Greene / Jason Parson / Mike Harfield
All	N/A	March 16, 2005 / 1	New Document	Jason Parson / Mike Harfield

## 1. WEBSITE Addresses

### 1.1 BellSouth Ordering Guides

The WEBSITE address for the BellSouth Ordering Guide can be accessed by clicking [here](#) .

### 1.2 Tariff Reference

SMARTRing is offered subject to the terms and conditions of BellSouth Tariff FCC No. 1, Sections 6 and 7, State E Access, and GSST G7. BellSouth tariffs are available by clicking [here](#) .

### 1.3 Technical Reference

Technical specifications for SMARTRing® are available in BellSouth Technical Reference (TR) **73582** which can be downloaded from BellSouth's website by clicking [here](#) .



## 2. SMARTRing® Service

### 2.1 Overview

The information in chapter 2 of this ordering guide addresses information that is unique to BellSouth's SMARTRing service.

**NOTE: This is Not a Complete Ordering Guide.**

For Detailed information regarding specific BellSouth Access Service Request (ASR) entries, please consult the Access Service Ordering Guide (ASOG).

### 2.2 General Description- SMARTRing® Service

BellSouth Dedicated Ring service is a SONET-based self-healing network with a ring architecture that ensures no single channel outage can interrupt service. The dedicated ring will be designed to meet the Customer's needs. Working from a minimum configuration of three (3) nodes (one of which must be a CO node) up to configurations with numerous customer nodes and central office nodes, the dedicated ring is a transport service that will grow with the Customer's network. BellSouth Dedicated Ring service is a flexible solution to the Customer's transport needs, with system sizes from Optical Carrier 3 (OC-3) up to Optical Carrier 192 (OC-192).

Using a BellSouth Dedicated Ring service to connect the customer's hubs with a backbone that provides the ultimate level of survivability. BellSouth Dedicated Ring service utilizes two separate rings, transmitting in opposite directions, to ensure each transmission is passed.

If a cut on one of the channels block transmission between two nodes on one of the rings, the ring transmitting in the opposite direction would still provide connectivity between the two nodes. An example of this configuration

is illustrated in the diagram below.

### SMARTRing Design Provides Fiber-loop Diversity to Customer Premises

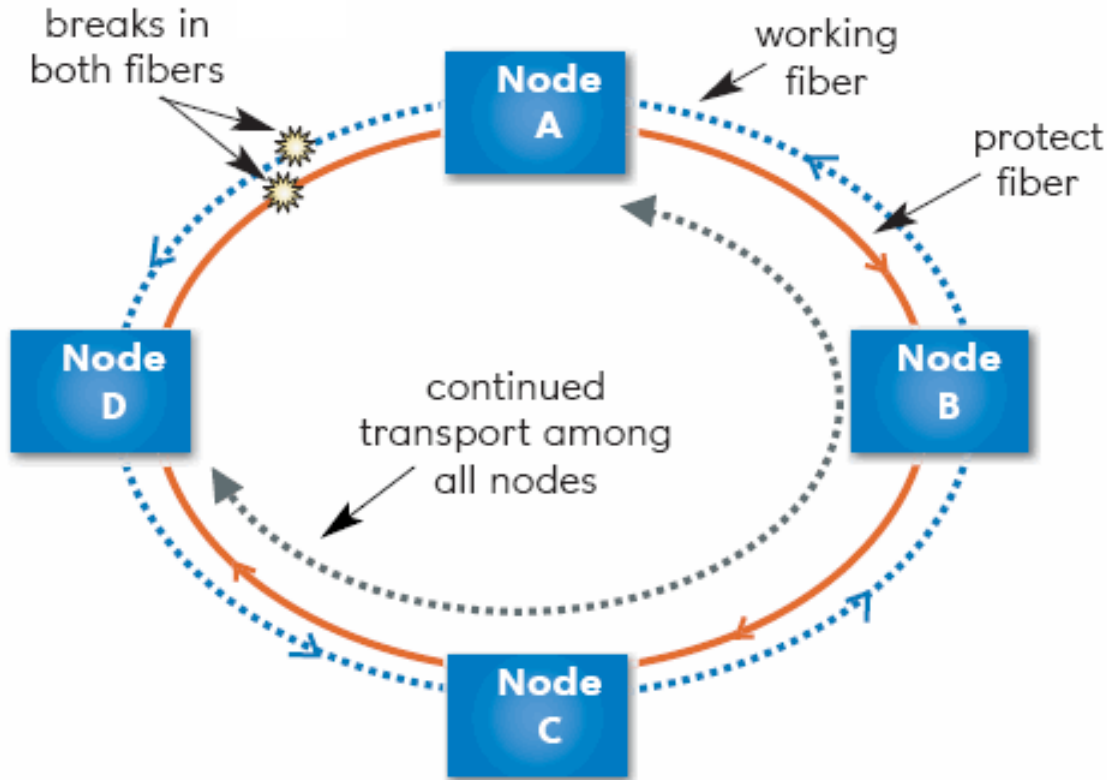

*SMARTRing Service uses a multi-node ring architecture designed to maintain transmission among all nodes even if both fibers are broken.*

BellSouth Dedicated Ring service is so reliable, it comes with its own guarantee. If the Customer's Dedicated Ring service has a ring failure that lasts **more than one second**, BellSouth will credit the Customer **100% of one month's recurring charges**.

## 3. Service and Feature Description

### 3.1 Service Description

BellSouth Dedicated Ring service is a SONET based, self-healing ring network in which the entire capacity is dedicated to a single customer. This ring service is designed for the transport of Switched and Special Access service between customer-designated hubbing locations.

BellSouth Dedicated Ring service offers customers with large levels of traffic in a metropolitan area an industrial strength transport product. Utilizing the BellSouth network and BellSouth Dedicated Ring service you can get the reliability and survivability that you need. And with BellSouth Customer Reconfiguration service you can manage your dedicated rings, making changes to your network in an instant.

Whether you are transporting voice, video, data traffic, or any combination of the above, SONET-based BellSouth Dedicated Ring service is up to the task.

### 3.2 Optional Features

Binary 8-Zero Substitution (B8ZS) with SuperFrame or extended SuperFrame, or extended SuperFrame only, is available on DS1 service only.

### 3.3 Service Availability

SMARTRing service is available in the Interstate and Intralata jurisdictions only. SMARTRing service is not available in the Intrastate (E) Access Tariff.

SMARTRing is available in FCC no.1, State E Access, and GSST B7.

## 4. Service Level Agreements

### 4.1 Quality Performance Objectives

The performance quality objectives of a Dedicated Ring Service circuit on the network side of the Network Interface (NI) are stated in terms of four parameters: Error Free Seconds (EFS), Severely Errored Seconds (SES), Service Availability and Service Continuity. Dedicated Ring performance objectives, stated in terms of the DS3/STS-1 level, are summarized in the table below:

Performance Parameters	Objective (Long Term)
% Error Free Seconds (%EFS)	EFS > 99.5%
% Severely Errored Seconds (%SES)	SES < 0.009%
% Annual Service Availability	Availability >99.99%
Service Continuity	Single Event Restoration < 1.0 seconds

### 4.2 Dedicated Ring Service DS3/STS-1 Quality Performance Objectives

Optical interfaces that are jointly engineered by BellSouth and the customer should be designed to have a Bit Error Ratio (BER) better than  $1 \times 10^{-10}$ . DS3/STS-1 service transported over these optical interfaces should meet or exceed the above service quality performance objectives. The performance of transported DS1 service **should** exceed 99.95% EFS.

### 4.3 Annual Service Availability

Long-term availability performance objective is better than 99.99% availability over 12 consecutive months. Circuit availability is a measure of the amount of time that the service is "usable" by the customer. According to the American National Standards Institute (ANSI) a service is assumed to be in the available state unless a transition to the unavailable state is observed without a subsequent transition to the available state. The transitions between the available and unavailable states are:

- Transition to the unavailable state occurs at the beginning of 10 consecutive SES.
- Transition to the available state occurs at the beginning of 10 consecutive seconds none of which are SES.

### 4.4 Service Continuity

The Service Continuity performance objective is that in the event of primary facility failure, service will switch to the alternate facility path in 1.0 second or less.

### 4.5 Credit for Service Outages

SMARTRing service carries a service guarantee in cases of an equipment failure. Should a failure occur in Telephone Company equipment resulting in a service outage of the entire system, and the system does not self-heal itself within one (1) second, the customer shall receive a credit equal to one months billing charges, provided the following conditions apply:

- The customer must report the trouble to the Telephone Company
- The trouble must have occurred in the Telephone Company equipment- not the customer equipment

No more than one credit shall apply per rate element per month regardless of the number of interruptions occurring during that month .

A credit **will not apply** for interruption during a customer initiated upgrade and/or addition to service.

A credit **will not apply** for interruptions due to a commercial power failure.

## 5. Network Interfaces

### 5.1 SMARTRing® Interface Elements

SMARTRing Service Channel interfaces provide DS1, DS3, STS-1, OC-3, OC-12, and/or OC-48 drop side interfaces at node locations.

**TABLE B. SMARTRing® Interface Elements**

Channel Interfaces	NODES							
	OC1	OC3	OC3+	OC12	OC48	OC48+	OC192	OC192+
<b>DS1</b>	Yes	Yes	Yes	No	No	No	No	No
<b>DS3</b>	No	Yes	Yes	Yes	Yes	Yes	Yes	Yes
<b>STS1</b>	Yes	Yes	Yes	Yes	Yes	Yes	Yes	Yes
<b>OC1</b>	No	No	No	Yes	Yes	Yes	No	No
<b>OC3</b>	No	No	No	Yes	Yes	Yes	Yes	Yes
<b>OC12</b>	No	No	No	No	Yes	Yes	Yes	Yes
<b>28 DS1 Channel System (DS3)</b>	No	No	No	No	Yes	Yes	Yes	Yes
<b>28 DS1 Channel System (STS1)</b>	No	No	No	No	Yes	Yes	Yes	Yes
<b>OC48</b>	No	No	No	No	No	No	Yes	Yes
<b>DS3 (Asymmetrical with DS1)</b>	No	Yes	Yes	No	No	No	No	No
<b>DS1 within STS1 Asymmetrical Arrangement</b>	No	Yes	Yes	No	No	No	No	No
<b>1000 Mbps</b>	No	No	No	No	Yes	Yes	Yes	Yes

### 5.2 Asymmetrical Interfaces

SMARTRing Service interfaces may be ordered as asymmetrical (i.e. a circuit enter one node at a lower level interface and exits at another node at a higher level interface).

The allowable asymmetrical interface arrangements for various SMARTRing System are shown in the table below:

**TABLE C. SMARTRing® Asymmetrical Channel Interfaces**

Asymmetrical Channel Interfaces	SMARTRing Nodes					
	OC-3	OC-3+	OC-12	OC-48	OC-48+	OC-192+
DS1- TDS3*	X	X	--	--	--	--
DS1- STS1	X	X	--	--	--	--
DS1- OC-3	--	X	--	--	--	--
DS3- STS1	X	X	X	X	X	--
DS3- OC-3	--	X	X	X	X	--
DS3- OC-12	--	--	--	X	X	--
TDS3*	--	X	--	--	--	--
STS1 — OC-3	--	X	X	X	X	--
STS1 — OC-12	--	--	--	X	X	--
OC-3 — OC-12	--	--	--	X	X	X
OC-3 — OC-48	--	--	--	--	--	X
OC-12 — OC-48	--	--	--	--	--	X

**NOTE:** The DS3 Asymmetrical with DS1 transmux feature eliminates the need for a separate M13 multiplexer function. It translates the asynchronous DS1s contained within a DS3 to VT1.5s contained within an STS-1.

### 5.3 SMARTRing® Asymmetrical Interface Combinations

The chart below details the asymmetrical interface combinations available through SMARTRing service. Click the appropriate link in the table to bring up the drawing associated with each combination:

**TABLE D. SMARTRing® Asymmetrical Interface OC3 Ring Combinations**

RING	DRAWING	DS1		DS3		TRANSMUX DS3		STS-1		OC-3		OC-12	
		CUC	COC	CUC	COC	CUC	COC	CUC	COC	CUC	COC	CUC	COC
OC-3													
	<a href="#">1B-1</a>	X	--	--	--	X	--	--	--	--	--	--	--
	<a href="#">1B-2, 1B-3</a>	X	--	--	--	--	X	--	--	--	--	--	--
	<a href="#">1A-3, 1C-2, 1C-4</a>	--	X	--	--	X	--	--	--	--	--	--	--
DS1-STS1	<a href="#">1C-1, 1C-3</a>	--	X	--	--	--	X	--	--	--	--	--	--
	<a href="#">2A-1</a>	X	--	--	--	--	--	X	--	--	--	--	--
	<a href="#">2B-1, 2B-2</a>	X	--	--	--	--	--	--	X	--	--	--	--
	<a href="#">2A-2, 2A-3</a>	--	X	--	--	--	--	--	X	--	--	--	--
	<a href="#">2C-1, 2C-2, 2C-3</a>	--	X	--	--	--	--	--	--	X	--	--	--
	<a href="#">3A</a>	--	--	X	--	--	--	X	--	--	--	--	--
DS3-STS1	<a href="#">3C</a>	--	--	X	--	--	--	--	--	--	--	--	--
	<a href="#">3B</a>	--	--	--	X	--	--	X	--	--	--	--	--
	<a href="#">3D</a>	--	--	--	X	--	--	--	X	--	--	--	--



**NOTE: For COCI must interconnect with a compatible service or transport and terminate in a Collocation Arrangement or Customer Premise.**

TABLE E. SMARTRing® Asymmetrical Interface OC3+Ring Combinations

RING	DRAWING	DS1		DS3		TRANSMUX DS3		STS-1		OC-3		OC-12	
		CUC	COC	CUC	COC	CUC	COC	CUC	COC	CUC	COC	CUC	COC
OC-3+	...												
DS1-TDS3	<u>1B-1</u>	X	--	--	--	X	--	--	--	--	--	--	--
	<u>1B-2</u> , <u>1B-3</u>	X	--	--	--	--	X	--	--	--	--	--	--
	<u>1A-3</u> , <u>1C-2</u> , <u>1C-4</u>	--	X	--	--	X	--	--	--	--	--	--	--
	<u>1C-1</u> , <u>1C-3</u>	--	X	--	--	--	X	--	--	--	--	--	--
DS1-STS1	<u>2A-1</u>	X	--	--	--	--	--	X	--	--	--	--	--
	<u>2B-1</u> , <u>2B-2</u>	X	--	--	--	--	--	--	X	--	--	--	--
	<u>2A-2</u> , <u>2A-3</u>	--	X	--	--	--	--	X	--	--	--	--	--
	<u>2C-1</u> , <u>2C-2</u> , <u>2C-3</u>	--	X	--	--	--	--	--	X	--	--	--	--
	<u>4B-1</u>	X	--	--	--	--	--	--	--	X	--	--	--
DS1-OC3	<u>4B-6</u>	X	--	--	--	--	--	--	--	--	X	--	--
	<u>4B-2</u> , <u>4C-2</u>	--	X	--	--	--	--	--	--	X	--	--	--
	<u>4C-3</u>	--	X	--	--	--	--	--	--	--	X	--	--
	<u>3A</u>	--	--	X	--	--	--	X	--	--	--	--	--
DS3-STS1	<u>3C</u>	--	--	X	--	--	--	--	X	--	--	--	--
	<u>3B</u>	--	--	--	X	--	--	--	--	--	--	--	--
	<u>3D</u>	--	--	--	X	--	--	--	--	--	--	--	--
	<u>4B-3</u>	--	--	X	--	--	--	--	--	X	--	--	--
DS3-OC3	<u>4B-7</u>	--	--	X	--	--	--	--	--	--	--	X	--
	<u>4B-4</u>	--	--	--	X	--	--	--	--	X	--	--	--
	<u>4C-4</u>	--	--	--	X	--	--	--	--	--	X	--	--
	<u>4C-4</u>	--	--	--	X	--	--	--	--	--	--	X	--

RING	DRAWING	DS1		DS3		TRANSMUX DS3		STS-1		OC-3		OC-12	
		CUC I	COC I	CUC I	COC I	CUC I	COC I	CUC I	COC I	CUC I	COC I	CUC I	COC I
OC-3+	...												
	<a href="#">4C-1</a>	--	--	--	--	--	X	--	--	X	--	--	--
	<a href="#">4C-5</a>	--	--	--	--	--	X	--	--	--	X	--	--
	<a href="#">4B-9</a>	--	--	--	--	X	--	--	--	X	--	--	--
STS1-OC3	<a href="#">4B-10</a>	--	--	--	--	--	X	--	--	--	X	--	--
	<a href="#">4B-5</a>	--	--	--	--	--	--	X	--	--	--	--	--
	<a href="#">4B-8</a>	--	--	--	--	--	--	X	--	--	X	--	--
	<a href="#">4D-4</a>	--	--	--	--	--	--	--	X	--	--	--	--
	<a href="#">4D-3</a>	--	--	--	--	--	--	--	--	X	--	--	--
			--	--	--	--	--	--	--	--	--	X	--

**NOTE: For COCI must interconnect with a compatible service or transport and terminate in a Collocation Arrangement or Customer Premise.**

TABLE F. SMARTRing® Asymmetrical Interface OC12 Ring Combinations

RING	DRAWING	DS1		DS3		TRANSMUX DS3		STS-1		OC-3		OC-12	
		CUC	COC	CUC	COC	CUC	COC	CUC	COC	CUC	COC	CUC	COC
OC-12													
	<a href="#">3A</a>	--	--	X	--	--	--	X	--	--	--	--	--
	<a href="#">3C</a>	--	--	X	--	--	--	--	X	--	--	--	--
	<a href="#">3B</a>	--	--	--	X	--	--	--	--	--	--	--	--
DS3-STS1	<a href="#">3D</a>	--	--	--	X	--	--	--	X	--	--	--	--
	<a href="#">4B-3</a>	--	--	X	--	--	--	--	--	X	--	--	--
	<a href="#">4B-7</a>	--	--	X	--	--	--	--	--	--	X	--	--
	<a href="#">4B-4</a>	--	--	--	X	--	--	--	--	X	--	--	--
DS3-OC3	<a href="#">4C-4</a>	--	--	--	X	--	--	--	--	--	X	--	--
	<a href="#">4B-5</a>	--	--	--	--	--	--	X	--	X	--	--	--
	<a href="#">4B-8</a>	--	--	--	--	--	--	X	--	--	X	--	--
	<a href="#">4D-4</a>	--	--	--	--	--	--	--	X	X	--	--	--
STS1-OC3	<a href="#">4D-3</a>	--	--	--	--	--	--	--	X	--	--	X	--

**NOTE: For COCI must interconnect with a compatible service or transport and terminate in a Collocation Arrangement or Customer Premise.**

**TABLE G. SMARTRing® Asymmetrical Interface OC48/OC48+ Ring Combinations**

RING	DRAWING	DS1		DS3		TRANSMUX DS3		STS-1		OC-3		OC-12	
		CUC	COC	CUC	COC	CUC	COC	CUC	COC	CUC	COC	CUC	COC
OC48/ OC48+	...												
	<a href="#">3A</a>	--	--	X	--	--	--	X	--	--	--	--	--
	<a href="#">3C</a>	--	--	X	--	--	--	X	--	--	--	--	--
	<a href="#">3B</a>	--	--	--	X	--	--	X	--	--	--	--	--
DS3- OC3	<a href="#">3D</a>	--	--	--	X	--	--	--	X	--	--	--	--
	<a href="#">4B-3</a>	--	--	X	--	--	--	--	--	X	--	--	--
	<a href="#">4B-7</a>	--	--	X	--	--	--	--	--	--	X	--	--
	<a href="#">4B-4</a>	--	--	--	X	--	--	--	--	X	--	--	--
DS3- OC12	<a href="#">4C-4</a>	--	--	--	X	--	--	--	--	--	X	--	--
	<a href="#">4B-3</a>	--	--	X	--	--	--	--	--	--	--	X	--
	<a href="#">4B-7</a>	--	--	X	--	--	--	--	--	--	--	--	X
	<a href="#">4B-4</a>	--	--	--	X	--	--	--	--	--	--	--	--
STS1- OC3	<a href="#">4C-4</a>	--	--	--	X	--	--	--	--	--	--	--	X
	<a href="#">4B-5</a>	--	--	--	--	--	--	X	--	X	--	--	--
	<a href="#">4B-8</a>	--	--	--	--	--	--	X	--	--	X	--	--
	<a href="#">4D-4</a>	--	--	--	--	--	--	--	X	--	--	--	--
STS1- OC12	<a href="#">4D-3</a>	--	--	--	--	--	--	--	X	--	X	--	--
	<a href="#">4B-5</a>	--	--	--	--	--	--	--	--	--	--	X	--
	<a href="#">4B-8</a>	--	--	--	--	--	--	--	--	--	--	--	X
	<a href="#">4D-4</a>	--	--	--	--	--	--	--	--	--	--	X	--
OC3- OC12	<a href="#">4D-3</a>	--	--	--	--	--	--	--	--	--	--	--	X
	<a href="#">5A-2</a>	--	--	--	--	--	--	--	--	X	--	X	--
	<a href="#">5B</a>	--	--	--	--	--	--	--	--	X	--	--	X
	<a href="#">5C-1</a>	--	--	--	--	--	--	--	--	--	--	X	--
	<a href="#">5C-2</a>	--	--	--	--	--	--	--	--	--	--	X	X

**NOTE: For COCI must interconnect with a compatible service or transport and terminate in a Collocation Arrangement or Customer Premise.**



TABLE H. SMARTRing® Asymmetrical Interface OC192+ Ring Combinations

RING	DRAWING	DS3		TRANSMUX DS3		STS-1		OC-3		OC-12		OC48	
		CUC	COC	CUC	COC	CUC	COC	CUC	COC	CUC	COC	CUC	COC
OC-192+	...												
OC3-OC12	<a href="#">5A-2</a>	--	--	--	--	--	--	X	--	X	--	--	--
	<a href="#">5B</a>	--	--	--	--	--	--	X	--	--	X	--	--
	<a href="#">5C-1</a>	--	--	--	--	--	--	--	X	--	--	--	--
	<a href="#">5C-2</a>	--	--	--	--	--	--	--	X	--	X	--	--
	<a href="#">6A-2</a>	--	--	--	--	--	--	X	--	--	--	X	--
	<a href="#">6B-1</a>	--	--	--	--	--	--	X	--	--	--	--	X
OC3-OC48	<a href="#">6C-1</a>	--	--	--	--	--	--	--	X	--	--	X	--
	<a href="#">6C-3</a>	--	--	--	--	--	--	--	X	--	--	--	X
	<a href="#">6A-3</a>	--	--	--	--	--	--	--	--	X	--	--	--
	<a href="#">6B-2</a>	--	--	--	--	--	--	--	--	X	--	--	X
	<a href="#">6C-2</a> , <a href="#">6C-5</a>	--	--	--	--	--	--	--	--	--	--	X	--
	<a href="#">6C-4</a> , <a href="#">6C-6</a>	--	--	--	--	--	--	--	--	--	--	--	X
OC12-OC48													

**NOTE:** For COCI must interconnect with a compatible service or transport and terminate in a Collocation Arrangement or Customer Premise.

### 5.4 SMARTRing® Level Elements

A graphical depiction of SMARTRing elements and how they interconnect is shown below:

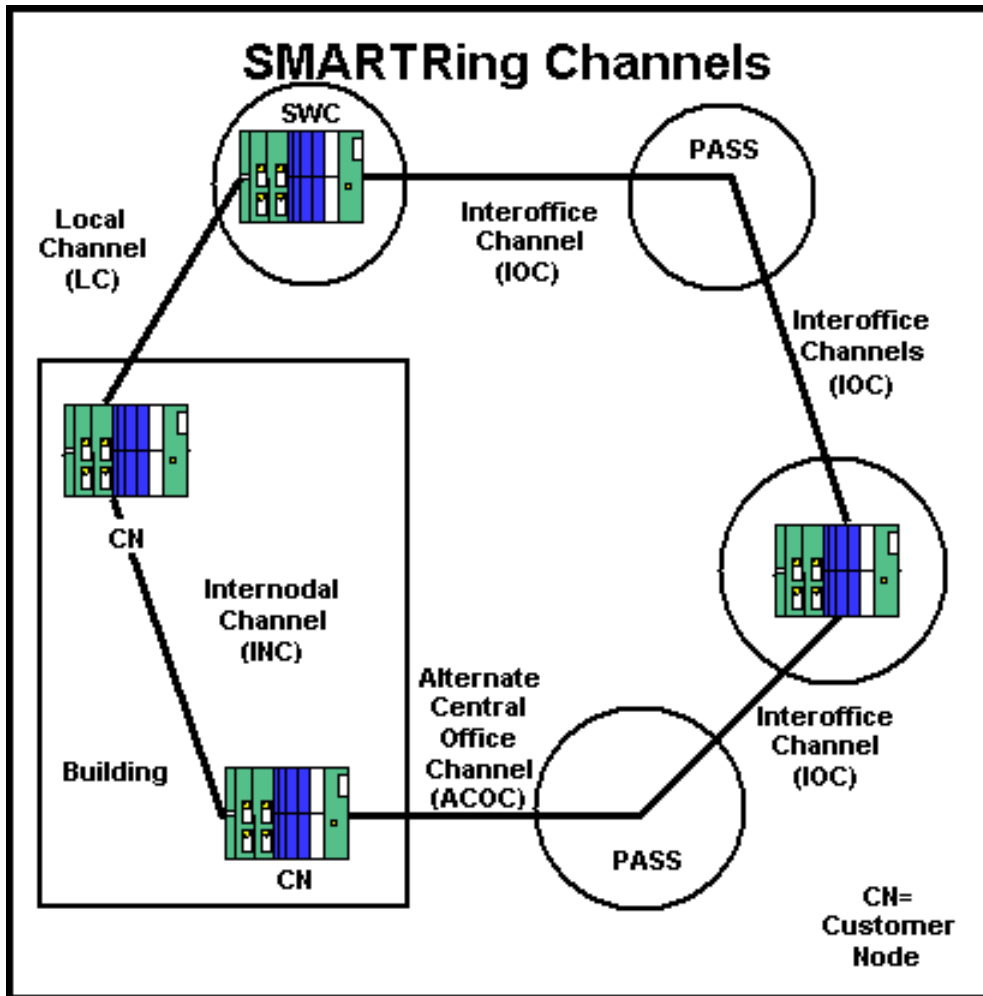

### 5.5 SMARTRing® Rate Elements Defined

**TABLE I. SMARTRing® Rate Elements**

**Customer Node-**Customer Nodes provide ring switching capabilities at customer designated locations other than Telephone Company Premises that are part of SMARTRing service.

<b>Customer Channel Interface-</b> A Customer Channel Interface provides DS1, DS3, STS-1 electrical channelization and/or OC-3, OC-12, OC-48 and/or 1000 Mbps optical channelization that may take place at each Customer Node or SMARTRing service.
<b>Central Office Node-</b> Central office Nodes provides ring-switching capabilities at Telephone Company Central offices that are part of SMARTRing service.
<b>Central Office Channel Interface-</b> A Central Office Channel Interface provides DS1, DS3, STS-1 electrical channelization and/or OC-3, OC-12, OC-48 and/or 1000 Mbps optical channelization that may take place at each Central Office Node located on SMARTRing service.
<b>Local Channel-</b> The Local Channel rate category provides for the communications path between a customer node and an alternate central office.
<b>Alternate Central Office Channel-</b> The Alternate Central Office Channel provides for communications path between a customer node and an alternate central office.
<b>Interoffice Channel-</b> The Interoffice Channel provides for the communications path between directly connected Telephone Company Offices located on a SMARTRing service.
<b>Internodal Channel-</b> The Internodal Channel (INC) provides for the communications path between two directly connected Customer Nodes of a given SMARTRing service.

## 5.6 SMARTRing® Flexible DS1 Interface

SMARTRing offers a wide range of Interfaces for multi-service access applications:

- DS1 to DS1
- DS1 to DS3 Asymmetrical Aggregation without additional Multiplexing or Overlays

The Flex DS1 tariff offering now allows OC-12 Rings to have a direct DS1 termination. These interfaces will now be offered as Flex DS1s. There is no technical difference in a regular DS1 interface and a Flex DS1 interface. This offering allows a direct termination onto the higher level rings (OC-12, OC-48 and OC-192) like the existing DS1 interfaces on OC-3 and OC3+ Rings which have the "VT1.5" CFA. The Flexible DS1 interface will also have a VT1.5 CFA until a future optical enhancement which will show the optical level of the Ring in the CFA and replace VT1.5 with OC03, OC12, OC48 and OC192. The diagram below shows aggregation available with

SMARTRing service:

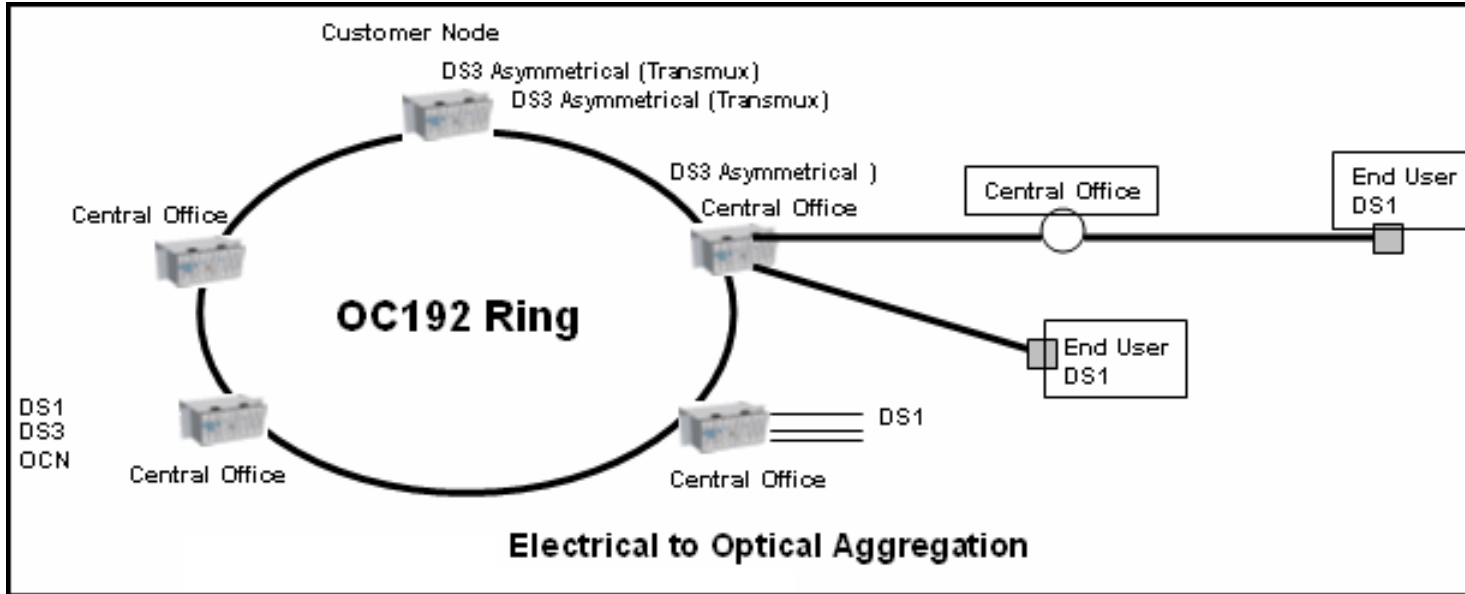

### 5.6.1 Flexible DS1 Interface

The following chart shows the availability of the Flex DS1 interface as a direct termination vs. the regular DS1/MegaLink/Light/Plus interface:

Ring Size	MSPP	Flex DS1 Interface	DS1/MegaLink/Light/Plus
OC3	No	No	Yes
OC3+	No	No	Yes
OC12	Yes	Yes	No
OC48	Yes	Yes	No
OC48+	Yes	No	No
OC192	Yes	Yes	No
OC192+	Yes	No	No

### 5.7 Flexible DS1 Interface Restrictions

Flexible DS1s are only available on the following SMARTRings:

- MSPP OC-12
- MSPP OC-48
- MSPP OC-192

## 5.8 SMARTRing® Service- 10/100 Mb and Incremental/Fractional ETHERNET for OC12/OC48/OC192

The Next Generation SONET (Synchronous Optical Network) will allow customers to gain efficiencies by utilizing BellSouth Dedicated Ring/SMARTRing to transport services via an Integrated or single platform. This service will extend customer LANs into the Metro Wide Area Network (WAN) area and beyond. Customers will be able to connect to carriers or other providers to carry the service to Interstate locations across the region or country. Optional Features provided by this service include the following:

- 10/100Mb ETHERNET as Transport Symmetrically across a ring or point-to-point service.
- Provide Incremental (Fractional) speeds of ETHERNET 50,150,300,450,600, in addition to 10/100/1,000 MB
- Provide these additional ETHERNET services across SMARTRing OC12, OC48, and OC192 ring capacities

## 5.9 Service Overview

The ETHERNET Private Line or Point-to-Point service is a service whereby BellSouth provisions native IEEE standard interfaces such as 10/100 Mb over MSPP SONET equipment such as the LUCENT DMX. MSPP allows BellSouth to deliver native ETHERNET interfaces via a single platform.

The following ports are supported on this platform:

1. 10/100Mb Ports: 10/100 Base-TX LAN Ports (Electrical)
2. 50/150/300/450/600/750/900Mb 1,000 Base-SX (Fiber)

These interfaces are suitable for Data Transport, Wireless Data, Video, Internet Access, LAN and IP Switch connectivity. This service also provides customer with direct connectivity to Routers and IP Switches.

## 5.10 Service Design

Optional designs for this service is as follows:

1. Symmetrical 10/100Mb (Incremental/Fractional) Speeds 50/100/350/450/600 at A-Z locations on a SMARTRing with terminating points at Customer nodes or C.O. Nodes.
2. Ring-Ring configuration where service is configured across a Dedicated Ring or SMARTRing.
3. Point-to-Point Service at customer premises and at central office via SPA Point to Point Service linked to SMARTRing C.O. Node
4. **Service will require a New Customer Channel Interface and Central Office Channel Rate Elements/USOC for Interfaces** (see table in next section)

## 5.11 ETHERNET Interfaces

New interfaces added to the current SMARTRing system sizes OC12, OC48, and OC192.

Ring Size	OC12	OC48	OC192
10 Mb Symmetrical	Yes	Yes	Yes
50 Mb Symmetrical	Yes	Yes	Yes
100 Mb Symmetrical	Yes	Yes	Yes
150 Mb Symmetrical	Yes	Yes	Yes
300 Mb Symmetrical	Yes	Yes	Yes
450 Mb Symmetrical	Yes	Yes	Yes
600 Mb Symmetrical	No	Yes	Yes
1,000 Mb existing	No	Yes	Yes

**NOTE: 1. Available for all Ring Capacities UPSR and BLSR**

**NOTE: 2. All Services are Unprotected**

## 5.12 SMARTRing® Channel Availability

**TABLE J. SMARTRing® Channel Interfaces**

Channel Interfaces Supported	DS1	DS3	28 DS1 DS3	OC-3	OC-12	10/100 Fractional 1000Mbps	100 Mbps	OC-48
OC-3 SMARTRing (155 Mbps)	Y	Y	Y	N	N	N	N	N
OC-3+ SMARTRing (622 Mbps)	Y	Y	Y	N	N	N	N	N
OC-12 SMARTRing (622 Mbps)	Y	Y	Y	Y	N	Y <sup>1</sup>	N	N
OC-48 SMARTRing (2.5 Gbps)	Y	Y	Y	Y	Y	Y	Y	N
OC-192 SMARTRing (10 Gbps)	Y	Y	Y	Y	Y	Y	Y	Y

**NOTE: 1. OC-12 when configured Fractional 1,000 Mb maximum is 450Mb**

## 6. Charges

### 6.1 Cancellation Charges

If a request is received to cancel a SMARTRing, normal cancellation charges will apply to the non-recurring charges on all circuits involved in the cancellation.

In addition, BellSouth will recoup all expenses incurred for equipment classified as capital investment.

Cancellation charges terms and conditions are found in Section 5.4 of the FCC#1 tariff.

## 7. Restrictions

### 7.1 Restrictions

There will be a *minimum of two nodes* on an Overlay Network. SMARTRing has a maximum number of 16 nodes for the host ring and the overlay ring. Special Assembly requests apply only to the GSST jurisdiction.

Shared Network Arrangements are prohibited between:

- Host Ring and Ring Overlays
- Ring Level and Digital Service Level 3 (DS3s)/ Synchronous Transfer Signal 1 (STS-1s)
- SMARTRing service at the Ring level

SMARTRing is not provided cross Exchange Company boundaries; therefore Meet Point Billing will not apply. Such requests will require Special Assembly processing. Independent Relations will assist with this negotiation.

An Optical carrier 3 (OC3) or Optical Carrier 12 (OC12) Synchronous Optical Network (SONET) SMARTRing **is not** considered an upgrade from an Optical Carrier 24 (OC24) Asynchronous SMARTRing.

OC3 or Optical Carrier 1 (OC1) Ring overlay networks activations are available on Optical carrier 12 (OC12), Optical Carrier 48 (OC48), and Optical carrier 48 + (OC-48+) Host Rings only.

Non-channelized SMARTRing DS3s cannot be provisioned beyond the Host Ring. Extension of a SMARTRing DS3 beyond the ring requires that it be cross-connected with another DS3 (i.e. a LightGate DS3 or a SMARTRing DS3 of a different Host ring. A CLS circuit ID format will be used when the SMARTRing DS3 is originating and terminating at a customer premise on the ring or when the SMARTRing DS3 is cross-connecting at a CO node with a DS3 off the ring.



## 8. FCC Tariff Payment Plans

### 8.1 Transport Payment Plan (TPP)

Rates and charges for all levels of SMARTRing service (Ring level, and all Activation levels) are available on a Month-to-Month basis, or under a contract payment plan.

Shared Network Arrangements are limited to a DS3 High Capacity service customer, and/or a DS1 High Capacity service customer sharing capacity with another sub-DS1 channel customer. This means that Shared Network Arrangements are not allowed between segments of the host ring, nor is it allowed for DS3s or DS1s that interface directly with the ring (integrated DS1s). Shared Network arrangements are allowed for DS1s that ride a SMARTRing DS3.

According to BSTC FCC #1 Section 7, all Host Ring level rate elements, whether initially or subsequently ordered, must be provided under the same payment plan with the same service period. This includes interface rate elements associated with any overlaying rings.

However, other channel interfaces may be provided either Month-to-Month or under a TPP that is equal to or less than the payment plan of the associated Host Ring. It is the customer's option to convert from an existing Channel Service Payment Plan (CSPP) prior to expiration, at the expiration of an existing CSPP arrangement, customers must renew the service under a TPP arrangement to maintain contract rates.

### 8.2 Minimum Bill Requirements

SMARTRing Service rate elements billed Month-to-Month carry a 12-month minimum billing period. (BSTC FCC #1 - 7.4.14.(A) (3)). SMARTRing rate elements selected under a TPP arrangement will require a minimum of 12 months.

Any SMARTRing rate element removed prior to the term plan selected will incur termination liability as described in BSTC FCC#1– 2.4.8 or in GSST B7 Section 2 for CSPP.

SMARTRing Service under a contract payment plan will also experience Termination Liability Charges (conditional) should the SMARTRing element be disconnected prior to the expiration of the contract (BellSouth FCC #1 - 7.4.14.(A) (3)). See subsection IV, Service Specific Billing.

At Ring Level, all rate elements for a given SMARTRing service, whether initially or subsequently ordered, must be provided under the same payment plan with the same service period. However, Channel Interfaces, except those associated with an overlay ring to its host ring, may be provided under a Month-to-Month or Transport Payment Plan (TPP) that is equal to or less than the payment plan for the associated SMARTRing service. (BellSouth FCC # 1 - 7.4.14.(A) (1)).

**NOTE: Channel interfaces may be placed under the same TPP plan or they may be placed month-to-month, a shorter or longer term than the ring level term under TPP.**

## 9. Service Inquiry

### 9.1 Service Inquiry Requirements

All SMARTRing service requests are project managed by BellSouth.

A project number will be assigned in accordance with the Interconnection Customer Service Center (ICSC) Project Coordination Process.

Due Date (DD) intervals are assigned by BellSouth Project Management.

The ICSC will receive a completed Service Inquiry (SI) Firm Order Design and as a billed sketch.

Upon receipt of "Firm Order" SI for Design, the ICSC will review and validate the information for accuracy and completeness. If the SI is incomplete it will be referred back to the BellSouth Account Team.

### 9.2 Due Date Intervals

The DD intervals are determined on an individual case basis. If the customer's requested DD cannot be met, the BellSouth Project Manager will assign the company's committed DD to the order.

## 10. Site Preparation

### 10.1 BICS Form Requirements

The Building Industry Consultant(BICS) must certify the building termination location. Click [here](#) to download a copy of general end user/property owner-provided requirements for fiber optic-based services.

**NOTE: Actual requirements will be provided by BICS after a site meeting with your local contact and the building owner. This meeting is required to provide service.**

## 11. Service Order Elements

### 11.1 Service Order Requirements

The service order(s) used to establish a SMARTRing Service Configuration will take place in two processes:

- Service Orders will be issued to establish the Ring itself. This is referred to as Ring Level. ***One (1) service order is required for each (Node-to-Node) segment of the Ring.***
- Separate service orders will be issued for each type service activation. Interface Universal Service Order Codes (USOCs) will be shown on the service order each time a service is activated and is applied per node location.

### 11.2 SNID (SONET Network Identification)

A Ring network will be identified with a SONET Network Identification (SNID). The SONET Network ID will be the overall ID for the Ring. It will consist of 6 alpha/numeric characters. In addition, individual Common Language Facility (CLF) IDs will be assigned to each node-to-segment on the Ring. These node-to-node segments are identified in SONET as an OC-1, OC-3, OC-3+, OC-12, OC-24, OC-48, OC-48+, OC-192 or OC-192+.

The SNID for an overlay Ring network will be different from the Host Ring, but will be formatted using the same criteria as the Host Ring.

**NOTE: The SNID for a HUB Ring will have a different SNID from the Host Ring.**

#### 11.2.1 SONET Network ID Format

The **1<sup>ST</sup> character** of the SNID *is always an N*.

The **2<sup>nd</sup> character** will indicate an Alpha representing the State where the Ring is being provisioned. The table below identifies the State and the Code used:

State	Code
Alabama	A
Georgia	G
Louisiana	L
Mississippi	M
North Carolina	N
North Florida	F
South Carolina	C
South East Florida	E
South Florida	S
Tennessee	T

### 11.3 Connecting Facility Assignment

Identifies the provider carrier system and channel to be used from a Wideband Analog, High Capacity or Optical Network facility when the Customer has assigned control.

**Example:**

*/CFA A1234 STS3 4 CLLICODEA CLLICODE B*  
**A1234= SNID of Host Ring**

**Facility Destination** is a code that for a specific type of facility, uniquely identifies a path between two network nodes (1-5 Alpha/Numeric Characters)

**STS3= System/Facility Type**

**Facility Type** is a code that describes a type of facility when it is other than a single base band channel on cable. (1-6 Alpha/Numeric Characters)

**4 = Channel/Pair/Time Slot**

**Channel/Pair/Time Slot** is a code that identifies a specific assignable portion of a facility. (1-5 Alpha/Numeric Characters)

**CLLICODEA = A LOC (Originator)**

**Location A** is a standardized code that uniquely identifies the location of facility terminal A, which has the lower in Alpha/Numeric sequence of the two (2) facility locations. (8 or 11 Alpha/Numeric Characters)

**CLLICODEB = Z LOC (Terminator)**

**Location B** is a standardized code that uniquely identifies the location of facility terminal A, which has the higher in Alpha/Numeric sequence of the two (2) facility locations. (8 or 11 Alpha/Numeric Characters)

### 11.4 Transmission Path for the Ring (ID's)

The following IDs apply to make up the identification of the transmission path for the Ring:

<b>SNID-</b> Identification of the Ring as a whole
<b>CLF-</b> (OC-12) Node A to Node B segment
<b>CLF-</b> (OC-12) Node B to Node C segment
<b>CLF-</b> (OC-12) Node C to Node D segment
<b>CLF-</b> (OC-12) Node D to Node A segment

### 11.5 Billing Account Number

SMARTRing can be placed on an existing Billing Account Number (BAN) should the customer already have a Special Access account established. Otherwise a new BAN will be established using current rules for the

establishment of Special Access BANs. Presently, because Shared Network Arrangements are not allowed at Ring Level, all segments of the ring must be billed to the same customer, and must be established on the same BAN. If the Customer has an existing BAN, the Customer will populate the BAN field on the ASR with the **BAN or with an E, for existing**

**Example:**

**404 N10-1111**

If the Customer does not have an existing BAN, the Customer will populate the **BAN field on the ASR with an N**, which alerts the Interconnection Connection Service Center (ICSC) Service Representative that a BAN needs to be established for the Customer. The new BAN will be provided to the Customer when the Firm Order Confirmation (FOC) is returned.

**11.6 Service Related Field Identifiers (FIDs)**

**TABLE K. Special Access SMARTRing Asymmetrical Interface FIDS**

FID	Description
<b>DIR1- DIR4</b> Directionality One (1) thru Four (4)	Indicates the direction of the circuit's path when it enters on a bi-directional SONET ring identified by the Intermediate Connecting Facility Assignment and the customer has assignment control.
<b>DPEA</b> Drop Port Equipment	Indicates drop ports and/or equipment at the entry point or the provider's network when the customer has assignment control.
<b>DPEZ</b> Drop Port Equipment Assignment - Location Z	Indicates drop ports and/or equipment at the exit point of the providers's network when the customer has assignment control.
<b>ICF1-ICF4</b> Intermediate Connecting Facility Assignment One (1) thru Four (4)	Indicates the intermediate segment and channel to be used from a Wideband Analog, a High Capacity Facility or an Optical Network between provider locations when the customer has assignment control.
<b>KDIR</b> Connecting Facility Assignment Directionality	Indicates the directions of circuit's path when it enters on a bi-directional SONET ring identified by the Connecting Facility Assignment and the customer has assignment control.
<b>RNID</b> Related Sonet Network Identifier	Indicates the related Synchronous Optical Network (SONET) identification number.
<b>VTIA</b> Virtual Termination Identifier- Location A	Indicates the virtual assignments used in conjunction with the "Starting Number Assignment" element of the <b>DPEA</b> FID.
<b>VTIZ</b> Virtual Termination Identifier- Location Z	Indicates the virtual assignments used in conjunction with the "Starting Number Assignment" element of the <b>DPEZ</b> FID.

## 12. ASR Requirements

### 12.1 ASR Requirements

SMARTRing ring level service orders are issued by BellSouth. The ASR for ring level by the customer is optional. Services or channel interfaces activated on the ring such as DS1, DS3, or OC3 require customers to submit ASRs for activation. The Ordering and Billing Forum (OBF) is the responsible for the establishment of the ASR guidelines. Various software vendors provide electronic interface solutions for ASRs and your BellSouth Account Team Representative can assist you with information on how to obtain access to the Electronic Access Ordering (EAO) system or Carrier Access Front End (CAFE) system , which are BellSouth's online ASR interfaces.

If you have any questions or are in need of additional information please contact your BellSouth Account Team Representative.

### 12.2 Access Service Request Screen (ASR)

The ASR fields contain information directly related to the service being ordered. Valid fields on the for are listed below in the table:

**TABLE L. ASR Form (Screen)- Administrative Section**

FIELD	POPULATE WITH	USAGE
CCNA	Customer Carrier Name Abbreviation (3 Alpha Characters)	<b>REQUIRED</b>
PON	Purchase Order Number- Identifies the Customer's unique purchase order number for the request. (16 Alpha/Numeric characters)	<b>REQUIRED</b>
VER	Version Identification- Identifies the Customer's version number. (2 Alpha/Numeric Characters)	CONDITIONAL Initial ASR Request= 00; if sending SUPP then assign next number (Example: 01 then 02 then 03)

FIELD	POPULATE WITH	USAGE
ICSC	Interexchange Customer Service- Identifies the provider service center (4 Alpha/Numeric Characters) <b>Valid entries are:</b> <ul style="list-style-type: none"> <li>• SB01=GA</li> <li>• SB02=NC/SC</li> <li>• SB03=NF</li> <li>• SB04=SF</li> <li>• SC01=AL</li> <li>• SC02=KY</li> <li>• SC03=LA</li> <li>• SC04=MS</li> <li>• SC05=TN</li> </ul>	<b>REQUIRED</b>
CC	Company Code- Identifies the Exchange Carrier requesting local services ( 4 Alpha/Numeric Characters)	PROHIBITED- Restricted to FCC#1
D/SENT	Date and Time Sent- Identifies the date and time that the ASR is sent by the Customer. (17 Alpha /Numeric Characters including 3 hyphens) <b>Valid Entries are:</b> <ul style="list-style-type: none"> <li>• Two Digit Month (01-12)</li> <li>• Two Digit Day (01-31)</li> <li>• Two Digit Century (00-99)</li> <li>• Two Digit Year (00-99)</li> <li>• Two Digit Hour (01-12)</li> <li>• Two Digit Minute (00-59)</li> <li>• AM or PM</li> </ul>	<b>REQUIRED</b>
DDD	Desired Due Date- Identifies the Customer's Desired Due Date (10 Alpha/Numeric Characters)	<b>REQUIRED</b>
REQTYP	Requisition Type and Status- Identifies the type of service being requested and the status of the request (2 Alpha Characters) <b>Valid Entries are:</b> 1st Character (specifies type of service) 2nd Character (specifies the status of the request)	<b>REQUIRED</b>



FIELD	POPULATE WITH	USAGE
ACT	Activity- Identifies the activity involved in the service request. (1 Alpha Character) <b>Valid entries are:</b> <ul style="list-style-type: none"> <li>• N= New</li> <li>• D= Disconnection</li> <li>• C= Change or Modify existing service</li> </ul>	<b>REQUIRED</b>
RTR	Response Type Requested- Identifies the type of confirmation response requested by the customer. (2 Alpha/Numeric Characters) <b>Valid Entries are:</b> <ul style="list-style-type: none"> <li>• D=Send DOC only</li> <li>• F= Send FOC only</li> <li>• S= Send FOC and DLR</li> <li>• N=No response required</li> </ul>	<b>REQUIRED</b>
PIU	Percentage of Interstate Usage- Identifies the expected Interstate Usage for the access service for the request. (3 Alpha/Numeric Characters) <b>Valid Entries Are:</b> 100	<b>REQUIRED</b>
LTP	Local Transport- Identifies the switched access transport elements affected by this request. ( 4 Alpha/ Numeric Characters)	<b>REQUIRED</b>
ECCKT	Exchange Company Circuit ID- Identifies the provider Circuit ID (53 Alpha/Numeric Characters)	<b>REQUIRED- If ACT is C or D otherwise not populated</b>
QTY	Quality- Identifies the quantity involved in the service request	<b>REQUIRED</b>
BAN	Billing Account Number- Identifies the billing account number to which the recurring and non-recurring charges for the request will be billed ( 12 Alpha/ Numeric Characters) <b>Valid Entries are:</b> <ul style="list-style-type: none"> <li>• Valid BAN ( Example: 404 N00-0000)</li> <li>• N=New Billing Account requested</li> <li>• E= Existing</li> </ul>	<b>REQUIRED</b>
ACTL	Access Customer Terminal Location- Identifies the CLLI code of the Customer Facility terminal location. (11 Alpha/Numeric Characters)	<b>REQUIRED</b>
REMARKS	Remarks- Identifies a free flowing field, which can be used to expand upon and clarify other data on this request. (186 Alpha/ Numeric Characters)	<b>REQUIRED</b>

### 12.3 Administrative Screen (ADM)

The ICADM fields involve general administrative information. For more information regarding these fields, the Carrier may refer to the ASOG.

### 12.4 ASR-Bill Section

The Bill Section fields are used to specify bill details. Once data in these fields are established, they are optional on subsequent order activity unless a change is applicable to that specified originally.

**TABLE M. ASR Form/Screen- Bill Section**

Field	Populate With
BILLNM	Billing Name- Identifies the name of the person, office or company to whom the Customer has designated that the bill be sent (25 Alpha/Numeric Characters)
SBILLNM	Secondary Billing Name- Identifies the name of a department or group within the designated BILLNM entry (25 Alpha/Numeric Characters)
ACNA	Access Customer Name Abbreviation- Identifies the common language code for the Customer who should receive the bill for the ordered service (3 Alpha Characters)
STREET	Street Address (Bill)- Identifies the street of the billing address associated with the billing name. (25 Alpha/Numeric Characters)
FL	Floor (Bill)- Identifies the floor for the billing address associated with the billing name (3 Alpha/Numeric Characters)
RM	Room (Bill)- Identifies the room for the billing address associated with the billing name (6 Alpha/Numeric Characters)
CITY	City (Bill) - Identifies the city, village, township of the billing address associated with the billing name (25 Alpha/Numeric Characters)
ST	State (Bill)- Identifies the two character postal code for the state of the billing address associated with the billing name (2 Alpha Characters)
ZIP	Zip Code (Bill) - (12 Alpha/Numeric Character)
BILLCON	Billing Contact (15 Alpha/Numeric Characters)
TEL	Telephone Number Bill Contact (17 Numeric Characters- including 3 preprinted hyphens)
<a href="#">VTA</a>	Variable Term Agreement- (3 Alpha/Numeric Characters)

### 12.5 VTA- Variable Term Agreement

This field identifies the duration, identifying USOC, contract date or contract identification number of any variable term agreements. When ordering service under the TPP plan populate character position one with the

desired plan (A##). The next two characters are numeric and correspond to the number of months being committed under Plan A, Plan B, or Plan C.

**NOTE: This is an optional field unless ordering through a TPP arrangement.**

First Character Position- Alpha Character	Description
A	Standard Payment Plan (most commonly used)

**NOTE: As of October 15, 2005 customers who enter into a TPP billing arrangement with BellSouth may not prepay the outstanding recurring monthly rates in whole or in part for all rate elements included in the arrangement. Please refer to Carrier Notification letter — SN91085179.**

Contract payment plans available are as follows:

Type Payment Plan	Number of Months- Second Character Position-Numeric Character
Payment Plan A	12 Months to 36 Months
Payment Plan B	37 Months to 60 Months
Payment Plan C	61 Months to 96 Months

## 12.6 ASR- Contact Section

**TABLE N. ASR Screen- Contact Section**

Field	Populate With
INIT	Initiator- Identifies the Customer's employee who originated the request. (15 Alpha/Numeric Characters)
TEL NO	Telephone Number of Initiator- Identifies the telephone number of the number of Customer's employee who originated the request. (17 Numeric Characters- including 3 preprinted hyphens)
FAX NO	Initiator Facsimile Number- Identifies the fax number of the initiator. (12 Numeric Characters- including 2 preprinted hyphens)
STREET	Initiator Stress Address- Identifies the initiator's street address. ( 25 Alpha/ Numeric Characters)
FL	Floor- Identifies the floor of the initiator's address. (3 Alpha/Numeric Characters)
RM	Room- Identifies the room of the initiator's address. (6 Alpha/Numeric Characters)
CITY	City- Identifies the city of the initiator's address. (25 Alpha/Numeric Characters)
STATE	State- Identifies the two character postal code of the initiator's address ( 12 Alpha/Numeric Characters)

Field	Populate With
ZIP	Zip Code- Identifies the zip code or postal code of the initiator's address. (12 Alpha/Numeric Characters)
EMAIL	Initiator Electronic Mail Address- Identifies the electronic mail address of the Initiator. (60 Alpha/Number Characters)
DSGCON	Design Engineering Contact- Identifies the employee of the Customer or agent who should be contacted on the design/engineering matters and to whom the DLR will be sent. (15 Alpha Numeric Characters)
TEL NO	Telephone Number (DSGCON)- Identifies the telephone number of the Customer's employee who should be contacted on design/engineering matters. (17 Numeric Characters- Including 3 preprinted hyphens)
FAX NO	Design Facsimile Number- Identifies the fax number on the design contact. (12 Numeric Characters- including 2 preprinted hyphens)
DRC	Design Routing Code- Identifies the Customer's location routing code for the design contact for the request. (3 Alpha/Numeric Characters)
STREET	Street- Street Address (DGSCON)- Identifies the street address for the design/engineering contact. (25 Alpha/Numeric Character)
FL	Floor (DSGCON)- Identifies the floor of the design/engineering contact's address. (3 Alpha/Numeric Characters)
RM	Room (DSGCON)- Identifies the room of the design/engineering contact's address (6 Alpha/Numeric characters)
CITY	City (DSGCON)- Identifies the city of the design/engineering contact's address. (25 Alpha/Numeric Characters)
STATE	State (DSGCON)- Identifies the two character postal code for the state of the initiator's address. (22 Alpha Characters)
ZIP	Zip Code- Identifies the zip code or postal code of the design/engineering contact's address
EMAIL	DSGCON Electronic Mail Address- Identifies the electronic mail address of the DSGCON. (60 Alpha/Numeric Characters)
IMPCON	Implementation Contact- Identifies the Customer's employee who is responsible for control of installation and completion. (15 Alpha/Numeric Characters)
TEL NO	Telephone Number (IMPCON)- Identifies the telephone number of the implementation contact. (17 Numeric Characters- including 3 preprinted hyphens)
D/TREC	Date and Time received- identifies the date and time that the provider received the ASR (Automatically Populated)

## 12.7 ASR Transport Screen (SPE/SP2)

The SPE/SP2 screens must be completed for order or service that terminates to a carrier customer's POP. There are two screens in the electronic ordering systems: SPE captures information regarding the primary location and SP2 refers to the secondary location.

**TABLE O. ASR- SPE Screen**

<b>Field</b>	<b>Populate With</b>	<b>Usage</b>
NC	<p><b>Network Channel-</b>            Identifies the Network Channel (NC) code for the circuit(s) involved. The NC code describes the channel provided by BellSouth from the End User's location to:</p> <ul style="list-style-type: none"> <li>• a BellSouth central office</li> <li>• another End User location</li> </ul> <p>The NC also describes portions of a circuit:</p> <ul style="list-style-type: none"> <li>• ACTL to HUB</li> <li>• HUB to HUB</li> <li>• HUB to End User's location</li> </ul>	<b>Required-</b> 4 alpha/ Numerics
NCI	<p><b>Network Channel Interface Code-</b>            Identifies the electrical conditions on the circuit at the Primary Location.</p>	<b>Required-</b> Five (5) alpha/ numeric characters minimum, and twelve (12) alpha/numeric maximum
SECNCI	<p><b>Secondary Network Channel Interface-</b>            Identifies the electrical conditions on the circuit at the secondary ACTL or end user location</p>	<b>Required-</b> Five (5) alpha/ numeric characters minimum, and twelve (12) alpha/numeric maximum
CFA	<p><b>Connecting Facility Assignment-</b>Identifies the provider carrier system and channel to be used from a Wideband High Capacity or Optical Network when the customer has assignment control.</p>	<b>Conditional-</b> (42) alpha numeric characters.
MUX LOC	<p><b>Multiplexing Location-</b>Identifies the CLLI code of the BellSouth Central Office which provides multiplexing for a service riding a High Capacity (HICAP) service.  <b>Blank</b>=if multiplexing not associated.</p>	<b>Conditional-</b> Eight (8) or Eleven (11) alpha/ numerics
SCFA	<p><b>Secondary Connecting Facility Assignment-</b>Identifies the provider carrier system and channel to be used from a Wideband High Capacity or Optical Network when the customer has assignment control.</p>	<b>Conditional-</b> (42) alpha numeric characters

GETO	<b>General Exchange Tariff Options Code</b> -Identifies the requirement for the not-tariffed or secondary tariff options in conjunction with the Access Service. For Example, inside wiring at the customer's premises, when the primary location is an End User Customer. <b>Blank</b> =no options. Y= Provide inside wiring and bill End User Customer directly	<b>Optional</b> - (1) alpha character
WACD1	<b>Work Authorization Circuit Detail Link1</b> -This field identifies the first DS3 link to be cross connected with the DS3 identified in WACD2. The field is required when the service requested will be cross-connected to existing service.	<b>Conditional</b> -Up to 36 alpha/numeric character CFA assignment
WACD2	<b>Work Authorization Circuit Detail Link2</b> -This field identifies the first DS3 link to be cross connected with DS3 identified in WACD1.. This field is required when the service requested will be cross-connected to an existed service.	<b>Conditional</b> - Up to 36 alpha/numeric character CFA assignment
RMKS	<b>Remarks</b> -Identifies a free flow field which can be used to expand upon and clarify other data associated with the End User Special Access Request.	<b>Optional</b> - Up to (124) alpha/numerics

**TABLE P. ASR- SP2 Field**

Field	Populate With	Usage
MUXLOC	<b>Multiplexing Location</b> -Identifies the CLLI Code of the provider central office which provides multiplexing for a service riding a High Capacity Service.  <b>NOTE: Required when utilizing multiplexing services and the ACT field on the ASR Form in "N" or "C" otherwise optional.</b>	<b>Conditional</b> -8 or 11 alpha/numeric characters

SECLOC	<p><b>Secondary Location</b>-Identifies the terminating end of a circuit, a provider end office or the first point of switching for the circuit being provided.</p> <p><b>NOTE: The Secondary location of a ring segment which could be either a central office node or customer node. A customer node can be either an end user premise or an ACTL.</b></p> <p><b>Valid Entries:</b></p> <ul style="list-style-type: none"> <li>• C- CLLI Code - SECLOC is a central office node</li> <li>• E- End user name- SECLOC is a customer node.</li> </ul> <p><b>NOTE: When a "E" is entered in this field, the preassigned CLLI Code should be entered in the SPOT (SECLOC) field.</b></p> <p><b>NOTE: Required when the ACT field on the ASR Form is "N" or "C", otherwise optional.</b></p>	<p><b>Conditional</b>-25 alpha/numeric characters.</p>
EUNAME	<p><b>End User Name</b>- the end user name associated with the termination location.</p>	<p><b>Conditional</b>-25 alpha/numeric characters</p>
ADDRESS	<p><b>Address</b>- Identifies the address of the end users location</p>	<p><b>Required</b>-25 alpha/numeric characters</p>
CITY	<p><b>City</b>-Identifies the city, village, township, etc. of initiator's address</p>	<p><b>Required</b>-25 alpha/numeric characters</p>
RMKS	<p><b>Remarks</b>-Identifies a free flowing field which can be used to expand upon and clarify other data on this form.</p>	<p><b>Optional</b>- 186 alpha/numeric characters</p>

### 12.7.1 Network Channel (NC) Code Definition

NC codes are used to select and design most access services. The NC Code is a 4–Character code that consists of a Channel Code and Optional Feature Code. Character Position (CP) 1–2 is an alphanumeric code that identifies the channel service. CP3 further defines functions of the channel, and CP4 identifies the channel's features. A hyphen may be used in CP3 and/or CP4 to indicate a specific option.

#### 12.7.1.1 Network Channel (NC) Codes

**TABLE Q. SMARTRing® (OC-1 to OC-192) Ring Level NC/NCI Code Matrix**

Node Size	Central Office (CO) Link NC Code	Customer Node (CN) Link NC Code
OC-1	OAIC	OAKD
	OAIG (CNM)	OAKH (CNM)

Node Size	Central Office (CO) Link NC Code	Customer Node (CN) Link NC Code
<b>OC-3</b>	OBIC	OBKD
	OBIG (CNM)	OBKH (CNM)
<b>OC-3+/OC-12</b>	ODIC	ODKD
	ODIG (CNM)	ODKH (CNM)
<b>OC-12</b>	ODIC	ODKD
	ODIG (CNM)	ODKH (CNM)
<b>OC-48+/OC-48</b>	OFIC	OFKD
	OFIG (CNM)	OFKH (CNM)
<b>OC-192+</b>	OGIC	OGKD

**TABLE R. SMARTRing® Service Activation NC Codes**

NC Code	NC Code Description
<b>HF - -</b>	DS3 Non-Channelized
<b>HF-6</b>	DS3 Non-Channelized ATM UNI
<b>HF-D</b>	DS3 Non-Channelized Frame Relay UNI
<b>HF-E</b>	DS3 Non-Channelized Frame Relay NNI
<b>HF-J</b>	DS3 Non-Channelized Frame Relay NNI Via ATM
<b>HF-M</b>	DS3 Channelized Central Office Mux
<b>HF-P</b>	DS3 Channelized Mux at Both Ends, Customer Premises
<b>HF-Q</b>	DS3 Channelized Customer Premises
<b>HF-R</b>	DS3 Channelized Customer Premises & Central Office Mux
<b>HF-T</b>	DS3 Channelized TRANSMUX Central Office
<b>HF-T</b>	DS3 Channelized TRANSMUX Customer Premises
<b>HF-Y</b>	DS3 Channelized Mux at Both Ends, Central Office
<b>HFC-</b>	DS3 Non-Channelized C-BIT Parity
<b>HFC6</b>	DS3 Non-Channelized C-BIT Parity ATM UNI
<b>HFCD</b>	DS3 Non-Channelized C-BIT Parity Frame Relay UNI
<b>HFCE</b>	DS3 Non-Channelized C-BIT Parity Frame Relay NNI
<b>HFCJ</b>	DS3 Non-Channelized C-BIT Parity Frame Relay NNI Via ATM
<b>HFZM</b>	DS3 Channelized Central Office Mux, B8ZS Capable
<b>HFZP</b>	DS3 Channelized Mux at Both Ends, Customer Premises, B8ZS Capable



NC Code	NC Code Description
<b>HFZQ</b>	DS3 Channelized Customer Premises Mux, B8ZS Capable
<b>HFZR</b>	DS3 Channelized Central Office and Customer Premises Mux, B8ZS Capable
<b>HFZT</b>	DS3 Channelized TRANSMUX Central Office, B8ZS Capable
<b>HFZT</b>	DS3 Channelized TRANSMUX Customer Premises, B8ZS Capable
<b>HFZY</b>	DS3 Channelized Mux at Both Ends Central Office, B8ZS Capable
<b>JI - -</b>	STS-1 Non-Channelized
<b>JIAA</b>	STS-1 Channelized Mux at Central Office
<b>JIAB</b>	STS-1 Channelized Mux at Customer Premises
<b>JIAC</b>	STS-1 Channelized Mux at Both Ends, Central Office
<b>JIAG</b>	STS-1 Channelized Mux at Both Ends, Customer Premises
<b>OB - -</b>	OC-3 Non-Channelized Non-Concatenated
<b>OB-C</b>	OC-3 Mux at Central Office
<b>OB-D</b>	OC-3 Mux at Customer Premises
<b>OB-E</b>	OC-3 Mux at Both Ends
<b>OB-R</b>	OC-3 Non-Channelized Concatenated
<b>OBA6</b>	OC-3 Non-Channelized ATM UNI
<b>OBIC</b>	OC-3 SMARTRing Central Office
<b>OBIG</b>	OC-3 CNM SMARTRing Central Office
<b>OBKD</b>	OC-3 SMARTRing Customer Premises
<b>ODKH</b>	OC-3 CNM SMARTRing Customer Premises
<b>OD-</b>	OC-12 Non Channelized Non-Concatenated
<b>OD-C</b>	OC-12 Mux at Central Office
<b>OD-E</b>	OC-12 Mux at Both Ends
<b>OD-D</b>	OC-12 Mux at Customer Premises
<b>OD-E</b>	OC-12 Mux at Both Ends
<b>OD-R</b>	OC-12 Non Channelized Concatenated
<b>ODA6</b>	OC-12 Non Channelized ATM UNI
<b>ODIC</b>	OC-12 SMARTRing Central Office
<b>ODIG</b>	OC-12 CNM SMARTRing Central Office
<b>ODKD</b>	OC-12 SMARTRing Customer Premises
<b>ODKH</b>	OC-12 CNM SMARTRing Customer Premises

NC Code	NC Code Description
<b>OF - -</b>	OC-48 Non-Channelized Non-Concatenated
<b>OF-C</b>	OC-48 Mux at Central Office
<b>OF-D</b>	OC-48 Mux at Customer Premises
<b>OF-E</b>	OC-48 Mux Both Ends
<b>OF-R</b>	OC-48 Non-Channelized Concatenated
<b>OFIC</b>	OC-48 SMARTRing Central Office
<b>OFIG</b>	OC48 CNM SMARTRing Central Office
<b>OFKD</b>	OC-48 SMARTRing Customer Premises
<b>OFKH</b>	OC-48 CNM SMARTRing Customer Premises
<b>OG-E</b>	OC-192 Mux at Both Ends
<b>OGIC</b>	OC-192 SMARTRing Central Office
<b>OGKD</b>	OC-192 SMARTRing Premises

### 12.7.2 Network Channel Interface (NCI) Code Definition

Network Channel Interface (NCI) code identify the interface characteristics at an Access customer or end user customer Point of Termination (POT). The NCI code provides the means to identify to CO or POT physical and electrical/optical characteristics.

NCI node provides for the type interface at the Node as well as the Node allocation for the type activations anticipated. Node allocations will only apply at the 1st Node of each Node-to-Node segment.

#### 12.7.2.1 NCI Codes

On a Ring or Ring Overlay, the NCI will be formatted as follows:

**TABLE S. SMARTRing® NCI Codes**

Characters	NCI Code(s)
1st - 4th Character	02SM (OC-1, OC-3, OC-3+, OC-12) <b>OR</b> 02SN (OC-48, OC-48+)
5th Character	F= Fiber <b>OR</b> 6= Electrical
6th Character	(.) Delimiter
7th-9th Character	Represents Node Allocation

## 13. USOCS- Universal Service Order Codes

### 13.1 Class of Service

USOCs are the primary source driving information for service provisioning and billing of all services and equipment shown on a service order or customer record. When used on a service order, they provide proper billing for recurring and non-recurring charges. USOCs are a combination of three or five alphanumeric characters used on service orders and equipment records to identify items of service and equipment in BellSouth.

The Class of Service USOCs for SMARTRing at Ring Level, and at overlay level, are listed below:

Type of Service	Class of Service USOCS
OC-1 Capacity	XENO (Alpha O)
OC-3 Capacity	XDEO3 (Alpha O)
OC-3+ Capacity	XDE12
OC-12 Capacity	XDE12
OC-48 Capacity	XDE48
OC-48+	XDE49
OC-192+	XDE92

### 13.2 Rate Elements USOCS

This rate element represents the charge for SMARTRing switching equipment located as a Customer designated premise necessary to interface service activations.

Rate Elements	USOCS
Customer Premise Nodes (CN)	SHNC4 (OC-1)
	SHNC3 (OC-3)
	SNHC1 (OC-3+)
	SHNC1 (OC-12)
	SHNN8 (OC-48)
	SHNN9 (OC-48+)
	SHNN5 (OC-192)
	SHNN2 (OC-192+)

### 13.3 Central Office Nodes

This rate element represents the charge for the SMARTRing switching equipment at a Telephone Company HUB Office that is necessary to interface service activations.

Rate Elements	USOCS
Central Office Nodes (CN)	SHNH4 (OC-1)
	SHNH3 (OC-3)
	SNHH1 (OC-3+)
	SHNH1 (OC-12)
	SHNH8 (OC-48)
	SHNH9 (OC-48+)
	SHNH7 (OC-192)
	SHNH6 (OC-192+)

### 13.4 Customer Premise Channel Interface

The Customer premise channel interface rate element applies at the location where the Overlay Ring shares the same Customer premise Node as the Ring Node. This rate element applies for the interface of the Overlay Ring to the Host Ring at this Node location.

Customer Premise Channel Interface	USOCS
Per OC-1 on OC-12	SHN1C
Per OC-1 on OC-48	SHN1C
Per OC-1 on OC-48+	SHN1C
Per OC-3 on OC-12 (4 Fiber)	SHN15
Per OC-1 on OC-12 (2 Fiber)	SHN1D
Per OC-1 on OC-48 (4 Fiber)	SHN18
Per OC-3 on OC-48 (Fiber)	SHN1E
Per OC-3 on OC-48+ (2 Fiber)	SHN1E
Per OC-12 on OC-48 (4-Fiber)	SHN19
Per OC-12 on OC-48 (2 Fiber)	SHN1F
Per OC-48 or OC-48+ on OC-192 or OC-192+ (4-Fiber)	SHN1B
Per OC-48+ on OC-192 or OC-192+ (2 Fiber)	SHN1B

### 13.5 Local Channel (LC)

The Customer premise channel interface rate element applies at the location where the Overlay Ring shares the same Customer premise Node as the Ring Node. This rate element applies for the interface of the Overlay Ring to the Host Ring at this Node location.

- 1HVXX (All Ring Sizes except OC-1) - 1st ¼ mile
- 1HVIX (All Ring Sizes except OC-1) - 1st ¼ mile

### 13.6 Alternate Central Office Channel (ACOC)

The alternate central office channel USOC represents the charge for the local loop provided between a Customer's designed premise and an alternate central office for the purpose of alternate central office routing for the protect path. The ACOC is charged in 1st 1/4 mile increment and each additional 1/4 mile increment.

- 1HVAXX (All Ring Sizes except OC-1) - 1st 1/4 mile
- 1HAIX (All Ring Sizes except OC-1) - Each additional 1/4 mile

### 13.7 Internodal Channel (INCH)- Same Serving Wire Center

Internodal Channel, which represents the 1st and additional 1/4 mile increment, charged for OC3, OC12, and OC24 facility directly connecting two customer premises, which would normally be served by the same wire center.

- 1HNXX (All Ring Sizes except OC-1) - 1st 1/4 mile
- 1HNAX (All Ring Sizes except OC-1) - Each additional 1/4 mile

**NOTE:** *This is the Same Serving Wire Center*

### 13.8 Internodal Channel (INCH)- Contiguous Serving Wire Center

Contiguous Channel USOC represents the 1st and additional 1/4 mile increment charge for OC3, OC12, OC24 facility directly connecting two customer premises that are located in the same office park/campus environment or contiguous property that would normally be served by the same contiguous serving wire center.

- 1HNZX (All Ring Sizes except OC-1) - 1st 1/4 mile
- 1HNBX (All Ring Sizes except OC-1) - Each additional 1/4 mile

**NOTE:** *This is a Contiguous Wire Center*

### 13.9 Interoffice Channel (IOC)

The interoffice channel USOC represents the charge for a connecting one Telephone Company CO to another Telephone Company CO going clockwise around the Ring. Each central Office that passes transmission will be represented on the service order by a Common Language Location identifier (CLLI) code. The IOC is measured and charged in 1/4 mile increments, and, the quantity shown on the service order will be total number of 1/4 mile increments (there is not a first and additional rate element as with other mileage increments discussed in this section).

1HXFX (All Ring Sizes except OC-1)

**NOTE:** *This rate element is charged on a fixed and per 1/4 mile basis, but is represented on the service with one USOC*

## 14. Service Activations

### 14.1 STS-1 Point-to-Point Activation

Once the SMARTRing transmission path has been established, another possible activation type is a point-to-point STS-1 electrical interface circuit. An STS-1 may also be referred to as a SONET DS3.

An STS-1 (51.84 Mbps) electrical interface may take place at a SmartRing Customer Node (CN) or at a SmartRing Central Office Node (CON). The STS-1 interface applies for each STS-1 that terminates at a CN and/or that terminates at a CON. The STS-1 CN or CON interface rate element may also be used for connecting an OC12 CN or CON to an OC1 node to provide DS1 channel interfaces. The STS-1 CN or CON applies per STS-1 interface, per node.

They can be activated to originate and terminate between any two-node locations on the SMARTRing.

**STS-1 Customer Channel Interfaces are available on the following SMARTRing systems:**

- OC-1
- OC-3
- OC-3+
- OC-12
- OC-48
- OC-48+

**STS-1 Central Office Channel Interfaces are available on the following SMARTRing systems:**

- OC-1
- OC-3
- OC-3+
- OC-12
- OC-48
- OC-48+

Unlike DS3 interfaces, this interface is capable of grouping DS1s from any nodes on the SMARTRing into a single 51.84 Mbps payload and maintaining SONET overheads when connected to SONET Distributed Communications Systems (DCSs) or Add/Drop Multiplexers (ADMs).

Additionally, a 28 DS1 Channel System (STS-1) is available and provides for the channelization of any STS-1 that the customer wants to connect to other services at the DS1 level in a SMARTRing Central Office Node. One 28 DS1 Channel System (STS-1) applies instead of the STS-1 Central Office Channel Interface when the customer wants a DS1 to channelize to a DS1 level in the Central Office. This rate element will be used primarily with OC-12 and above SMARTRings when the customer wants a DS1 interface at a CON and an STS-1 interface at another node.

**Billing Account Number (BAN)** must be under the same BAN as the highest level SMARTRing.

**Class of Service USOC** for an STS-1 activation will be:

Type of Service	Class of Service USOC
STS-1 Point to Point Activation	XDEST

CLS - Circuit ID will be in serial number format:

**Example:**

CLS A3.JIGS.123456..XX

**TABLE T. Network Channel**

Position Character	Populate With	Description
1st and 2nd Characters	Jl	(STS-1 Electrical Interface)
3rd Character	-	(Dash)
4th Character	- or X	(Dash= Prem to Prem) (X= Connect to Different Ring)

**TABLE U. Network Channel Interface**

Position/Characters	Populate With	Description
1st, 2nd, 3rd and 4th Characters	04ST	(STS-1)
5th Character	6	(Electrical)
6th Character	-	(Delimiter)
7th Character	A	(Alpha A)

**Connecting Facility Assignment (CFA)**

When an STS-1 activation is requested, CFA back to the higher-level ring **will be required**. The CFA format will be the same as any service riding a higher-level ring.

**Example:**

A 1234 STS1 1 CLLICODEA CLLICODEC

**Rate Elements**

The USOCs used to represent rate elements unique to an STS-1 interface activation are as follows: There will be an interface USOC to represent the originating location and the terminating location.

Type of Service	Class of Service
STS-1 Point to Point	XDEST

Type of Service	USOC
<b>OC1/OC3/STS-1</b>	
Customer Premise Originating/Terminating Interface	SHN13
Central Office Originating/Terminating Interface	SHN02
<b>OC12/ STS-1</b>	
Customer Premise Originating/Terminating Interface	SHN14
Central Office Originating/Terminating Interface	SHN03

## 14.2 Optical Point to Point Activation

An optical point-to-point activation means that an OC1 or an OC3 has been activated between two (2) nodes on an OC12 host ring. This point-to-point circuit does not loop back to form an overlaying ring network.

Service order requirements as described in section 22.0 of this document for Point-to-Point activations also applies to Optical Point-to-Point activation except for the following:

Type of Service	Class of Service USOC
OC3 Point-to-Point	XDEO3 (OC3)

CLS - Circuit ID will always be in serial number format.

### Example:

CLS A3.JIGS.123456..XX

**TABLE V. Network Channel (NC)**

Position/Character	Populate With	Description
1st and 2nd Characters	Jl	(STS-1 Electrical Interface)
3rd Character	-	(Dash)
4th Character	- or X	(Dash= Prem to Prem) (X=Connect to Different Ring)

**TABLE W. Network Channel Interface**

Position/Character	Populate With	Description
1st, 2nd, 3rd, and 4th Characters	04SO	(4- Wire Optical SONET)
5th Character	F	(Fiber)
6th Character	-	(Delimiter)



Position/Character	Populate With	Description
7th Character	E	(SR, MLM/LED)

**SONET Network ID (SNID)**

An STS-1 Point-to-Point activation will carry the same SNID as the Ring it is riding.

**Connecting Facility Assignment (CFA)**

When Optical Point-to-Point activation is requested, CFA back to the higher-level ring **will be required**. The CFA format will be the same as any service riding a higher-level ring.

**Example:**

OC1 A 1234 STS1 1 CLLICODEA CLLICODEC  
 OC3 A 1234 STS3 1 CLLICODEA CLLICODEC

**Rate Elements**

The USOCs used to represent rate elements unique to an STS-1 interface activation are as follows: There will be an interface USOC to represent the originating location and the terminating location.

Type of Service	Class of Service
STS-1 Point to Point	XDEST

Type of Service	USOC
<b>OC1/OC3/STS-1</b>	
Customer Premise Originating/Terminating Interface	SHN13
Central Office Originating/Terminating Interface	SHN02
<b>OC12/ STS-1</b>	
Customer Premise Originating/Terminating Interface	SHN14
Central Office Originating/Terminating Interface	SHN03

**14.3 DS3 Activation**

Once the Ring transmission path has been established, DS3s can be activated to originate and terminate between any 2-node locations on the Ring. A DS3 activation is similar to an STS-1 in that it is also an electrical activation, however, 44.736 Kbps are delivered to the customer for terminating, cross-connecting, or channelization.

A DS3 that is activated to "ride" a Host SMARTRing arrangement is referred to as a SMARTRing DS3 "interface". SMARTRing DS3 can interface with any ring capacity except OC-1s.

SMARTRing DS3 interfaces can be activated between any two nodes on the Host SMARTRing. For example: it can be provisioned between a Customer Node and a Central Office Node on the host ring, or between two

Customer Nodes on the Host SMARTRing. The node locations involved will be reflected in the CLLI codes provided in the host SMARTRing CFA (CN and/or CON CLLI codes).

A SMARTRing DS3 cannot be extended beyond the two nodes on the ring. If the customer wants a DS3 arrangement to be extended beyond the host ring, it must be cross connected with another DS3 (i.e. cross-connected with a LightGate DS3 or a SMARTRing DS3 from a different host ring).

All rate elements associated with SMARTRing are billed at Ring level. When a DS3 is activated, rate elements used to "interface" with the Ring level nodes will apply on the DS3 circuit.

**Billing Account Number**

DS3 activations must be placed on the same BAN as the SMARTRing level billing.

**Class of Service**

The Class of Service for a DS3 activation is considered to be a DS3 "interface" to a SMARTRing service. Therefore the USOC definition is referred to as a "DS3 Channel Interface". Class of Service USOCs for a SMARTRing DS3 activation are listed below:

Type of Service	Class of Service
DS3 Channel Interface (Available with all Ring capacities except OC1)	XDEST

**Project Number (PRN)**

When a DS3 activation is ordered at the same time as the Ring level service, the same project number assigned to the Ring will also be assigned to the DS3(s).

**CLF Circuit ID**

CLF Circuit ID format will be used when the DS3 is being channelized.

**Example:**

101 T3 CLLICODEA CLLICODEZ

**TABLE X. Network Channel (NC) Codes**

NC Code	Description
HF-M	Channelized DS3
HF-V	Channelized DS3 with B8ZS
HF-N	Channelized DS3 (channelized at both ends)
HFHY	Channelized DS3 (cross-connecting in Central Office with B8ZS)

**TABLE Y. Network Channel Interface (NCI) and Secondary Network Channel Interface (SECNCI)**

NCI Code	SECNCI Code
04DS6.44	NA

### Connecting Facility Assignment (CFA)

When a DS3 is channelized, CFA will indicate the facility assignment (time slot) of the DS3 interface to the Ring. The CFA format will be the same as that of an STS-1 CFA activation except it will generally be provided as STS-1 (rather than STS-3).

**Example:**

A1234 STS1 4 CLLICODEA CLLICODEZ

SNID data should always be a part of SMARTRing level CFA. When formatting SNID as part of CFA, the N, which is always the 1st character of the SNID, will be dropped.

### Rate Elements

The USOCs used to represent rate elements unique to a DS3 interface for a channelized DS3 are as follows:

<b>Customer Premise Originating/ Terminating Interface</b>	<b>USOC</b>
Per DS3 on OC-3 or OC-3+	SHNZT
Per DS3 on OC-12 (current)	SHN12
Per DS3 on OC-12 (prior to 8/22/94)	SHNDT
Per DS3 on OC-12	SHNDT
Per DS3 on OC-48 or OC-48+	SHN16
<b>Central Office Channel Originating/Terminating Interface</b>	<b>USOC</b>
Per DS3 on OC-3 or OC-3+	SHNYT
Per DS3 on OC-12 (current)	SHN01
Per DS3 on OC-12 (prior to 8/22/94)	SHNWT
Per DS3 on OC-24	SHNWT
Per DS3 on OC-48 or OC-48+	SHNC6
<b>Central Office Channel Interface with DS3 Channelization</b>	<b>USOC</b>
Per DS3 Mux ( 28 DS1 Channel System)	SHNW8

There will be an interface USOC to represent the originating location and the MUX location of the DS3.

### CLS Circuit ID Format

A CLS Circuit ID format will be used when the DS3 is originating and terminating at a Customer premise or is cross-connecting at a Central Office (CO) node with a non-channelized DS3 off the Ring.

**Example:**

A3.HFGS.123456..XX

### Rate Elements (Prem to Prem Ring DS3 or Ring DS3 cross-connect to DS3 off Ring)

SMARTRing DS3 Interface USOCs will be applied at both the originating and terminating locations of the SMARTRing DS3. The USOCs that represent the rate elements unique to a Ring DS3 interface that is cross-connected to a different DS3 of the Ring as follows:

<b>OC3/DS3</b>	<b>USOC</b>
Customer Premise Originating/Terminating Interface	SHNZT
Central Office Originating/Terminating Interface	SHNZT
<b>OC12/OC24/DS3</b>	<b>USOC</b>
Customer Premise Originating/Terminating Interface	SHNDT
Central Office Originating/Terminating Interface	SHNWT

<b>NC Code</b>	<b>Description</b>	<b>NCI Code</b>	<b>SECNCI Code</b>
HF-X	Non-Channelized DS3 crossconnected with a DS3 off the host Ring	04DS6.44	04DS6.44
HF- -	Non-Channelized DS3 connecting to another customer premise node location on the Ring	04DS6.44	04DS6.44

### Rate Elements

(Prem-to-Prem Ring DS3 or Ring DS3 cross-connect to DS3 off Ring)

SMARTRing DS3 Interface USOCs will be applied at both the originating and terminating locations of the SMARTRing DS3. The USOCs that represent the rate elements unique to a Ring DS3 interface that is cross-connected to a different DS3 off the Ring are as follows:

<b>OC3/DS3</b>	<b>USOC</b>
Customer Premise Originating/Terminating Interface	SHNZT
Central Office Originating/Terminating Interface	SHNZT
<b>OC12/OC24/DS3</b>	<b>USOC</b>
Customer Premise Originating/Terminating Interface	SHNDT
Central Office Originating/Terminating Interface	SHNWT

### SONET Network ID (SNID)

The SNID that has been assigned to the Ring will be repeated at DS3 level.

## 14.4 DS1 Activation

There are two (2) types of DS1 services that can result from a SMARTRing request.

1. Available on with all Ring capacities except OC-12, DS1s can be activated directly out of SMARTRing node without having been channelized from a DS3. This is call an “integrated” DS1. Integrated DS1s

must carry the SONET Network ID (SNID) of its Host Ring., due to the relationship to SMARTRing service.

2. DS1s can also be derived from a SMARTRing DS3 after DS3 to DS1 Channelization has taken place. There are 28 DS1s per DS3. This type DS1 will carry a regular T3 pointing back to the DS3 on the SMARTRing.

**Example:**

CFA 101/T3/6/CLLICODEA/CLLICODEZ

DS1s that ride SMARTRing DS3s will not carry the SONET Network ID (SNID) of the DS3.

Below is a breakdown of CFA format for a DS1 riding a SMARTRing DS3 or an integrated DS1:

**CFA of DS1 riding a SMARTRing DS3**

103 T3 4 CLLICODEA CLLICODEZ

Identifier	Definition
103	System ID
T3	System Type
4	Channel Slot
CLLICODEA	A Location
CLLICODEZ	Z Location

**CFA of an Integrated DS1 activated directly from a SMARTRing Node**

T1234 VT1.5 123 CLLICODEA CLLICODEZ

Identifier	Definition
T1234	System ID
VT1.5	System Type
123	Channel Slot
CLLICODEA	A Location
CLLICODEZ	Z Location

**DS1 Riding a Ring DS3 Circuit Format**

The DS1 riding a Ring DS3 can either be ordered as a prem to prem or channelized with CFA indicating a T3 system type. The Circuit Ids will be accordingly.

**Prem to Prem = CLS Circuit ID**

**Example:**

A3.XXXX.123456..XX

Channelized = CLF Circuit ID

**Example:**

101 T3 CLLICODEA CLLICODEZ

Normal USOCs and FIDs will apply to a DS1 riding a SMARTRing except for the interface USOC. A SMARTRing DS1 interface USOC (SHNCA) is required for the DS1 to interface with the SMARTRing DS3.

**Integrated DS1 Circuit Format**

An integrated DS1 (with or without an STS-1 interface) activated at the SMARTRing node can be requested in two (2) types of configurations.

1. Originate at a Ring Node and terminating at a Ring Node. This type DS1 can either be prem to prem or channelized at a Central Office (CO) node.
  - Prem to Prem= CLS Circuit ID (A3.XXXX.123456..XX)
  - Channelized= CLF Circuit ID (103 T3 CLLICODEA CLLICODE Z)
2. Originate at a Ring Node and terminate as a location off Ring. This type DS1 must pass through a Central Office (CO) node in order to leave the Ring and terminate at a secondary location off the Ring.
  - Prem to Prem= CLS Circuit ID (A3.XXXX.123456..XX)
  - Channelized= CLF Circuit ID (103 T3 CLLICODEA CLLICODE Z)

An integrated DS1 will carry CFA indicating a VT1.5 system type, which is an indicator that the DS1 is being activated from a SMARTRing node and not a SMARTRing DS3.

NC Code	Description (Termination off the Host Ring)
HC- -	Integrated DS1 (Non-Channelized) that is terminated off the Host Ring
HC-M	Integrated DS1 (Channelized) that is terminated off the Host Ring
HCD-	Integrated DS1 (Non-Channelized) that is terminated off the Host Ring (with Extended Super Frame (ESF) and Alternate Mark Inversion (AMI))
HCDM	Integrated DS1 (Channelized) that is terminated off the Host Ring
HCE-	Integrated DS1 (Channelized) that is terminated off the Host Ring
HCEM	Integrated DS1 (Channelized) that is terminated off the Host Ring
NC Code	Description (Termination off the Host Ring)
HC- -	Integrated DS1 (Channelized) that is terminated off the Host Ring
HC-M	Integrated DS1 (Channelized) that is terminated off the Host Ring

## 15. Acronyms

### 15.1 Acronym Definition

Acronym	Definition
ACOC	Alternate Central Office Channel
ADM	Add/Drop Multiplexers
ALOC	Originating Location
ANSI	American National Standards Institute
ASOG	Access Service Ordering Guide
ASR	Access Service Request
BAN	Billing Account Number
B8ZS	Binary 8- Zero Substitution
BER	Bit Error Rate
CFA	Connecting Facility Assignment
CLF	Common Language Facility
CLLI	Common Language Location Identifier
CLS	BellSouth Circuit Identification
CN	Customer Node
CO	Central Office
CON	Central Office Node
CSPP	Channel Service Payment Plan
DCS	Distributed Communications Systems
DS1	Digital Service Level 1
DS3	Digital Service Level 3
EFS	Error Free Seconds
FCC	Federal Communications Commission
FOC	Firm Order Confirmation
ICSC	Interconnection Carrier Service Center
ID	Identification
INC	Internodal Channel
INCH	Internodal Channel (Contiguous SWC)
IOC	Interoffice Channel
Kbps	Kilo Bits per Second
Mbps	Mega Bits per Second
MSPP	Multi -Service Provisioning Platform

<b>Acronym</b>	<b>Definition</b>
<b>LAN</b>	Local Area Network
<b>LC</b>	Local Channel
<b>NC</b>	Network Channel
<b>NCI</b>	Network Channel Interface
<b>NI</b>	Network Interface
<b>OC1</b>	Optical Carrier 1
<b>OC3</b>	Optical Carrier 3
<b>OC12</b>	Optical Carrier 12
<b>OC24</b>	Optical Carrier 24
<b>OC48</b>	Optical Carrier 48
<b>OC48_</b>	Optical Carrier 48+
<b>PRN</b>	Project Number
<b>SECNCI</b>	Secondary Network Channel Interface
<b>SES</b>	Severely Errored Seconds
<b>SI</b>	Service Inquiry
<b>SNID</b>	SONET Network Identification
<b>SONET</b>	Synchronous Optical Network
<b>STS-1</b>	Synchronous Transfer Signal 1
<b>SWC</b>	Serving Wire Center
<b>TPP</b>	Transport Payment Plan
<b>TR</b>	Technical Reference
<b>USOC</b>	Universal Service Order Code
<b>WAN</b>	Wide Area Network
<b>ZLOC</b>	Terminating location



## Appendix A. SMARTRing Asymmetrical Interfaces

### A.1 Valid Interface Combinations

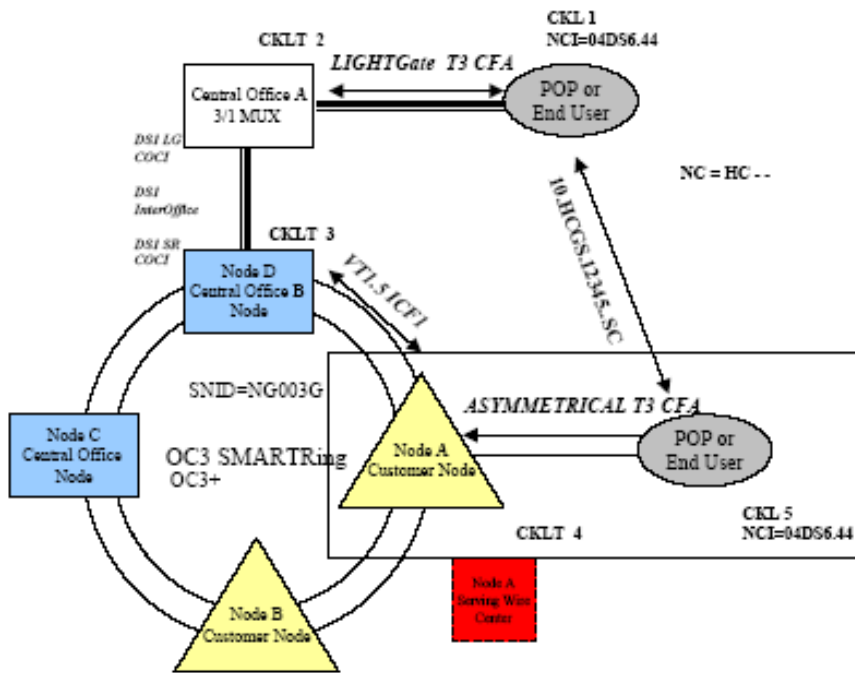

Figure 1. OC-3, OC-3+ Asymmetrical Drawing 1a-3

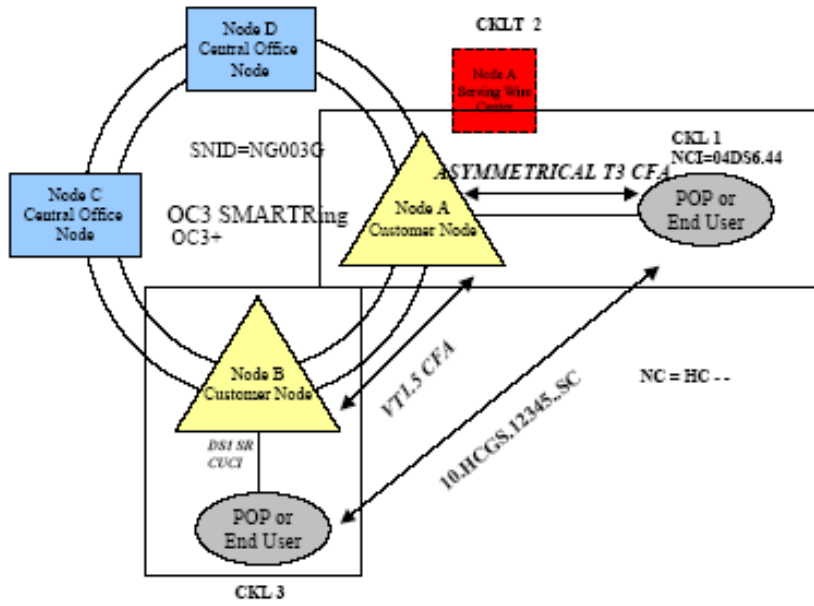

Figure 2. OC-3, OC-3+ Asymmetrical Drawing 1b-1

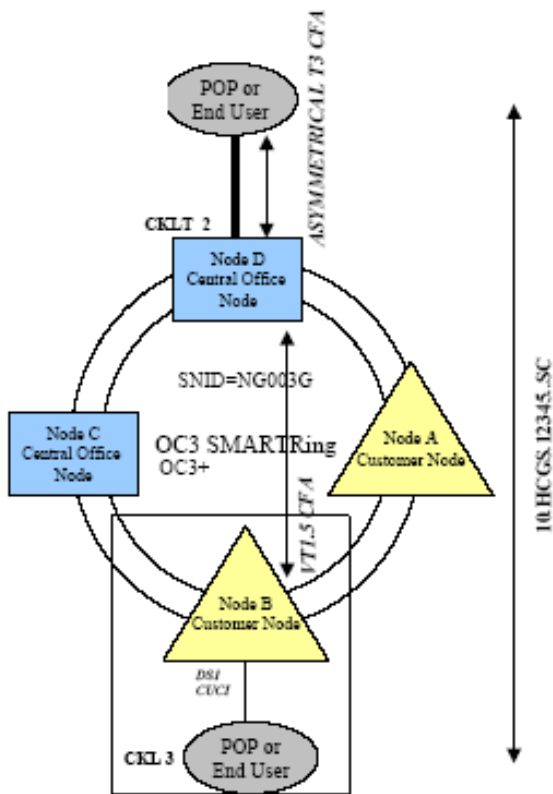

Figure 3. OC-3, OC-3+ Asymmetrical Drawing 1b-2

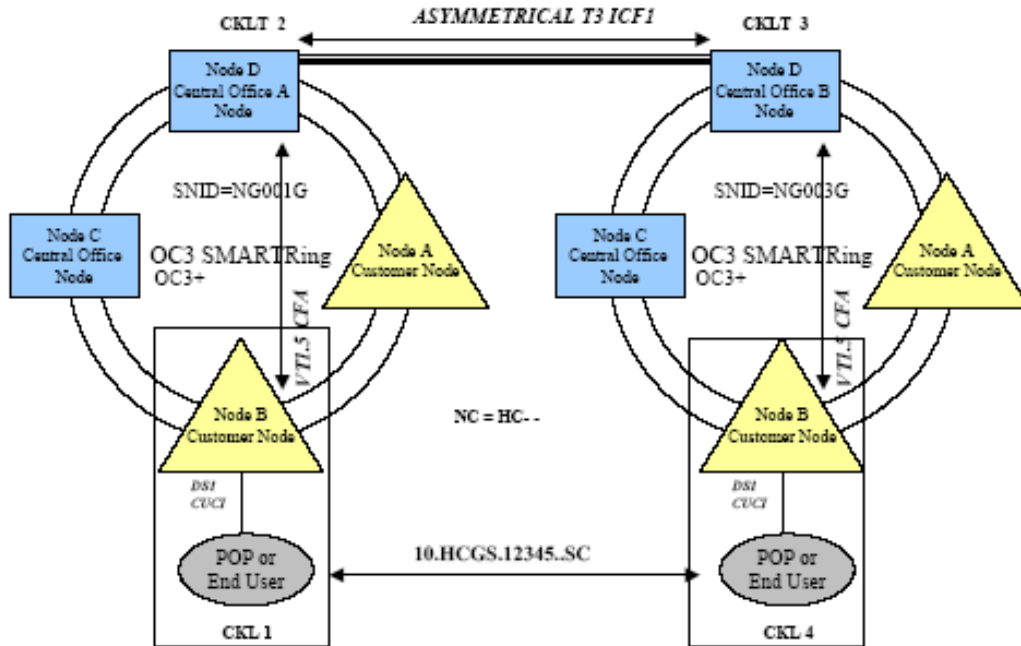

Figure 4. OC-3, OC-3+ Asymmetrical Drawing 1b-3

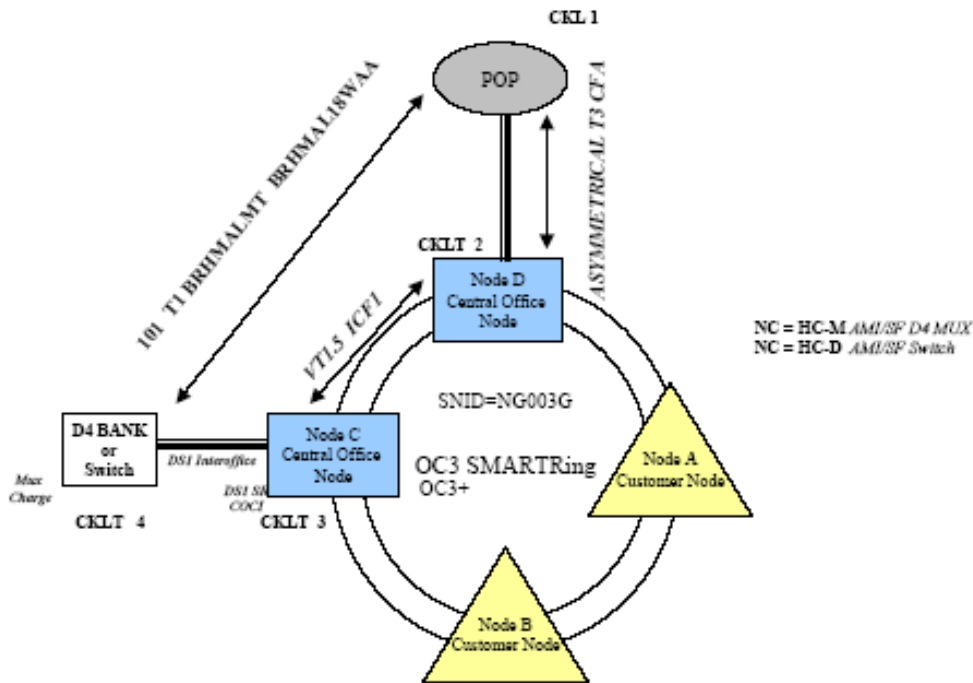

Figure 5. OC-3, OC-3+ Asymmetrical Drawing 1c-1

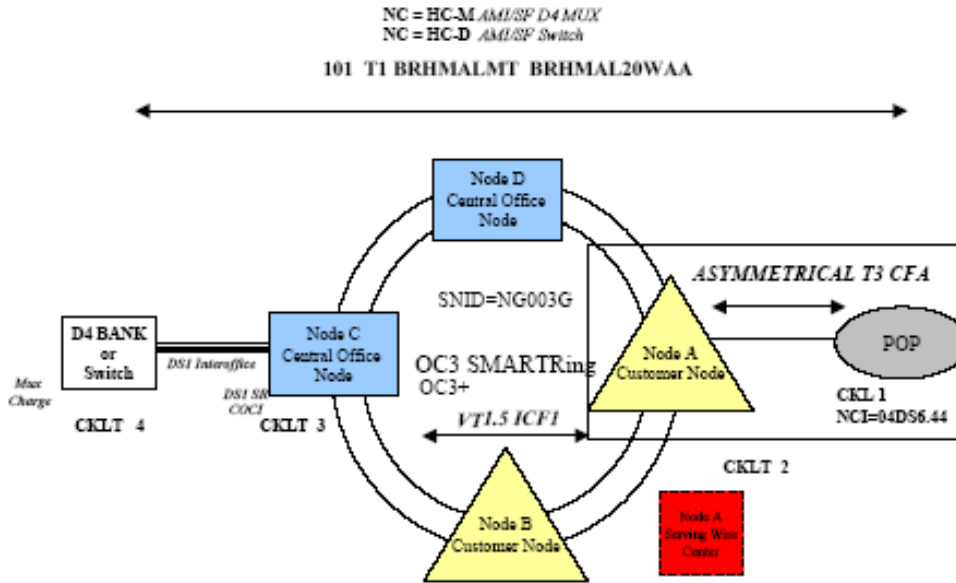

Figure 6. OC-3, OC-3+ Asymmetrical Drawing 1c-2

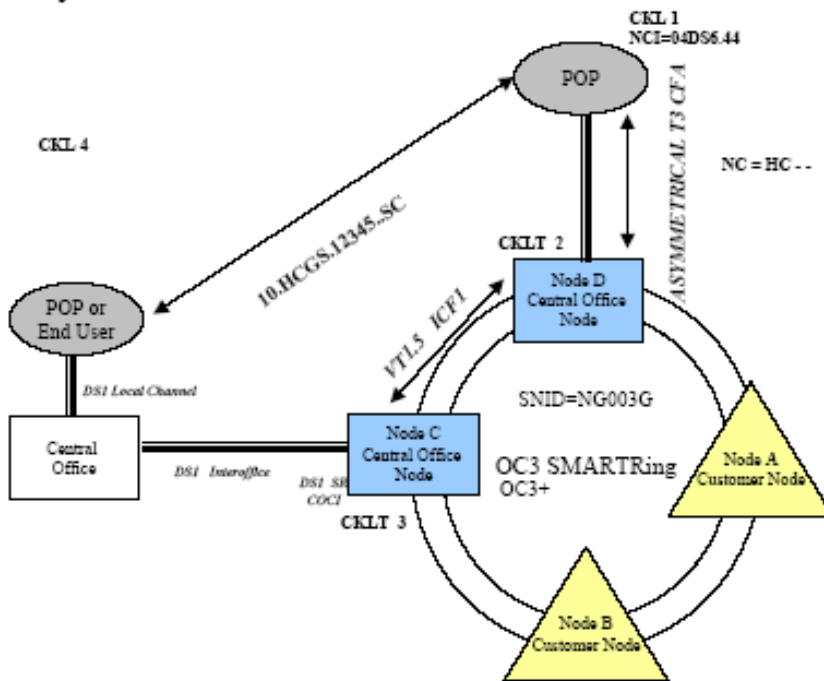

Figure 7. OC-3, OC-3+ Asymmetrical Drawing 1c-3

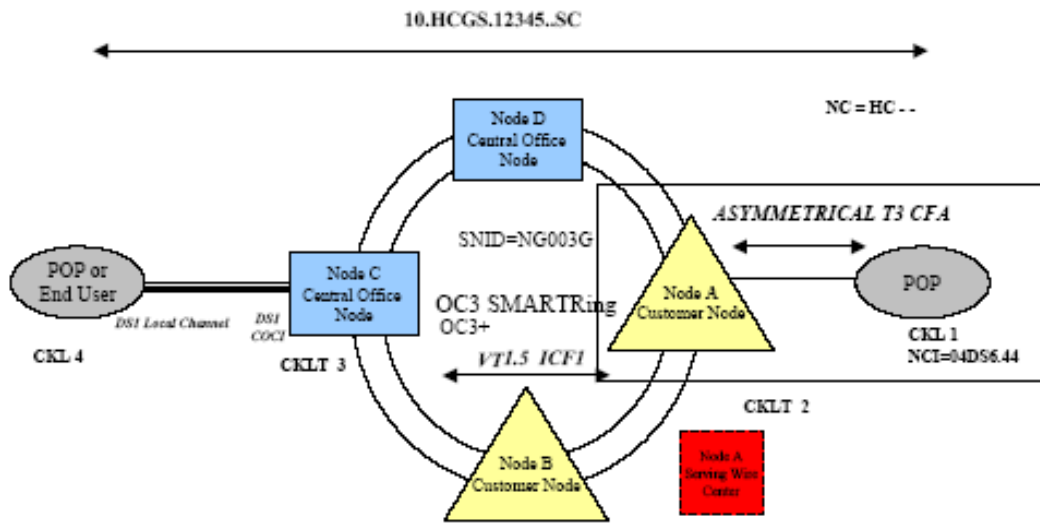

Figure 8. OC-3, OC-3+ Asymmetrical Drawing 1c-4

## A.2 Valid Interface Combinations

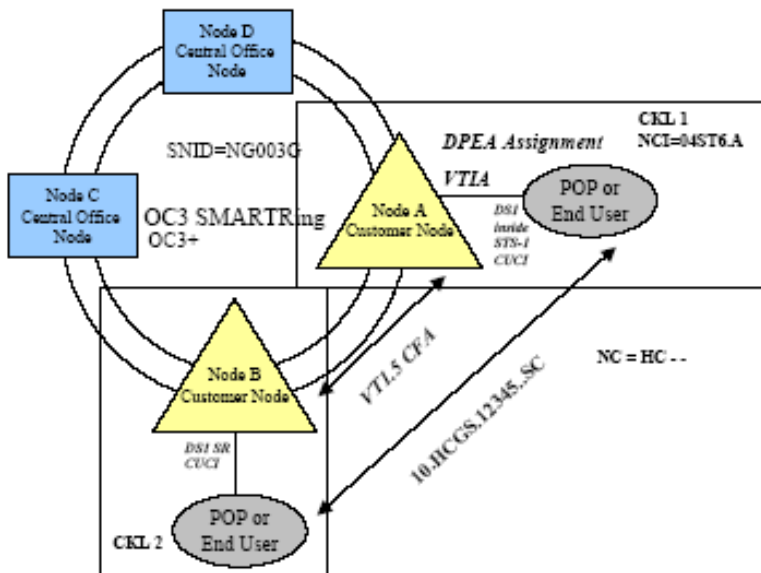

Figure 9. OC-3, OC-3+ Asymmetrical Drawing 2a-1

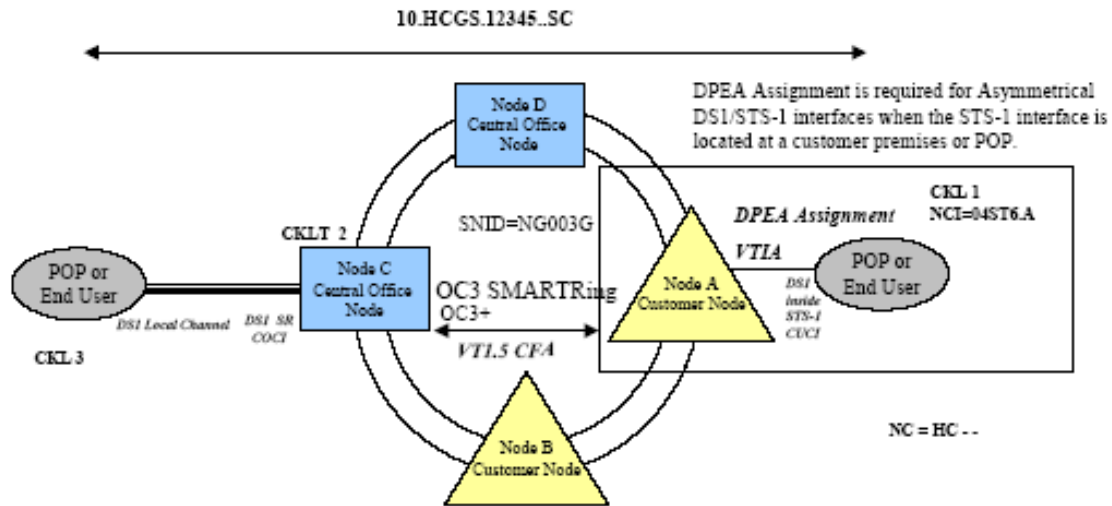

Figure 10. OC-3, OC-3+ Asymmetrical Drawing 2a-2

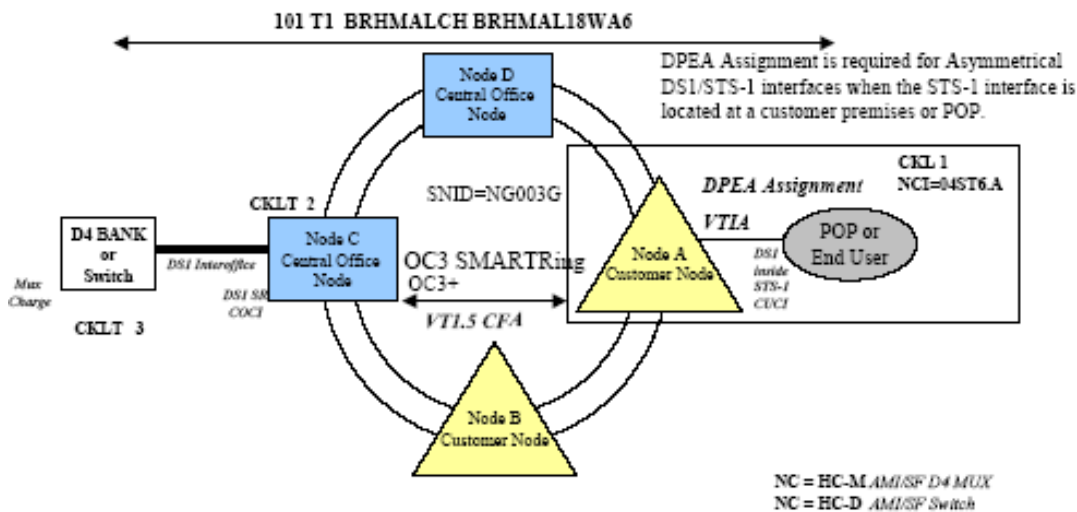

Figure 11. OC-3, OC-3+ Asymmetrical Drawing 2a-3

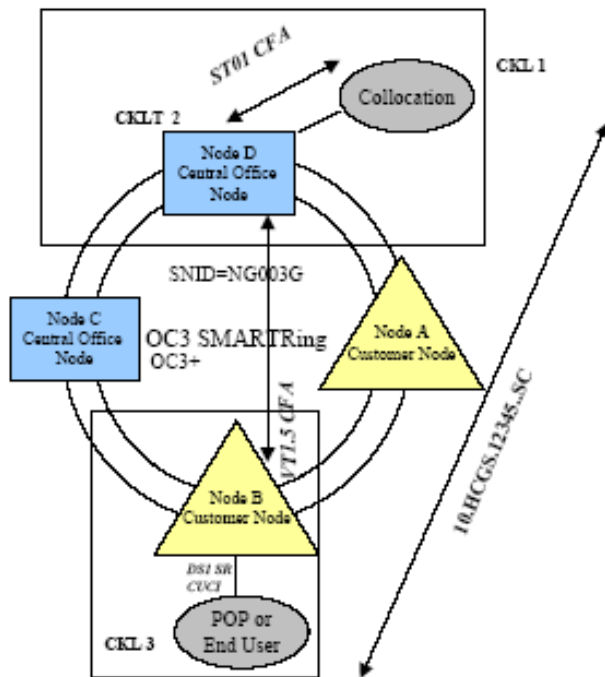

Figure 12. OC-3, OC-3+ Asymmetrical Drawing 2b-1

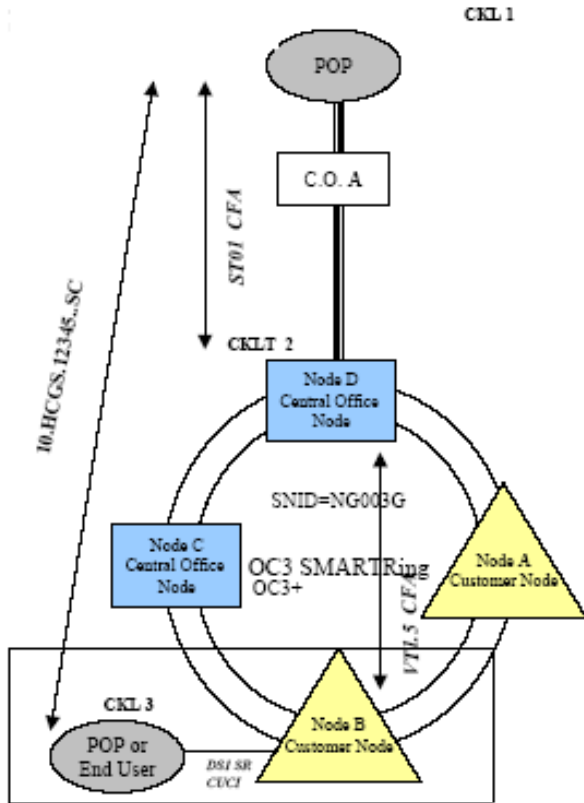

Figure 13. OC-3, OC-3+ Asymmetrical Drawing 2b-2



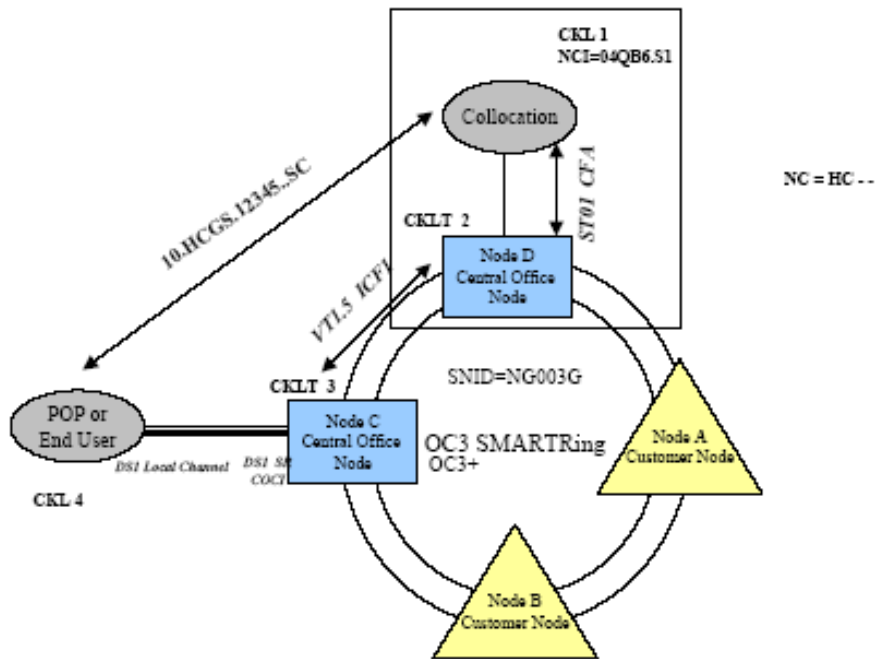

Figure 14. OC-3, OC-3+ Asymmetrical Drawing 2c-1

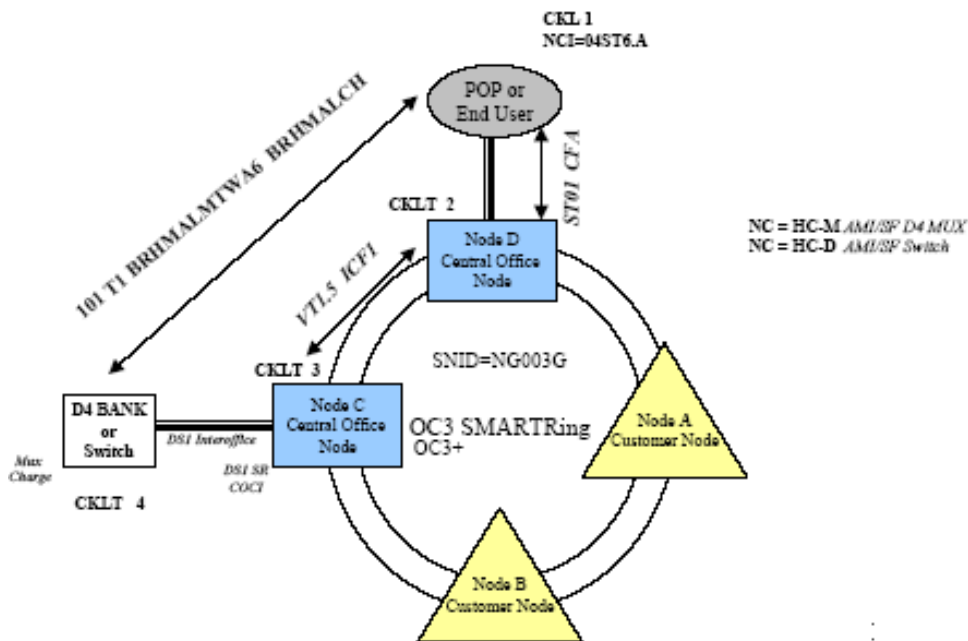

Figure 15. OC-3, OC-3+ Asymmetrical Drawing 2c-2

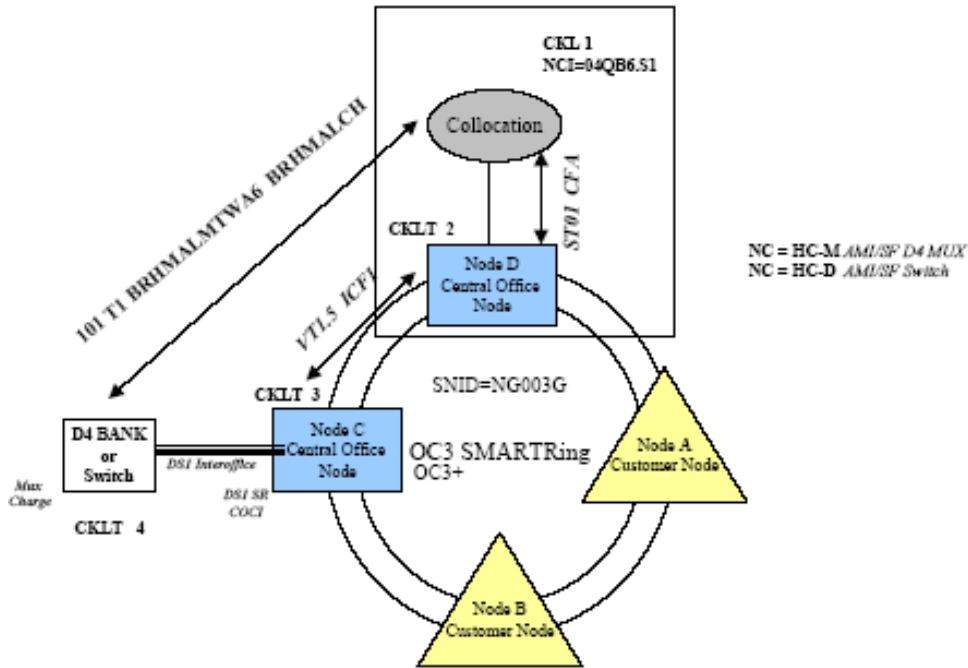

Figure 16. OC-3, OC-3+ Asymmetrical Drawing 2c-3

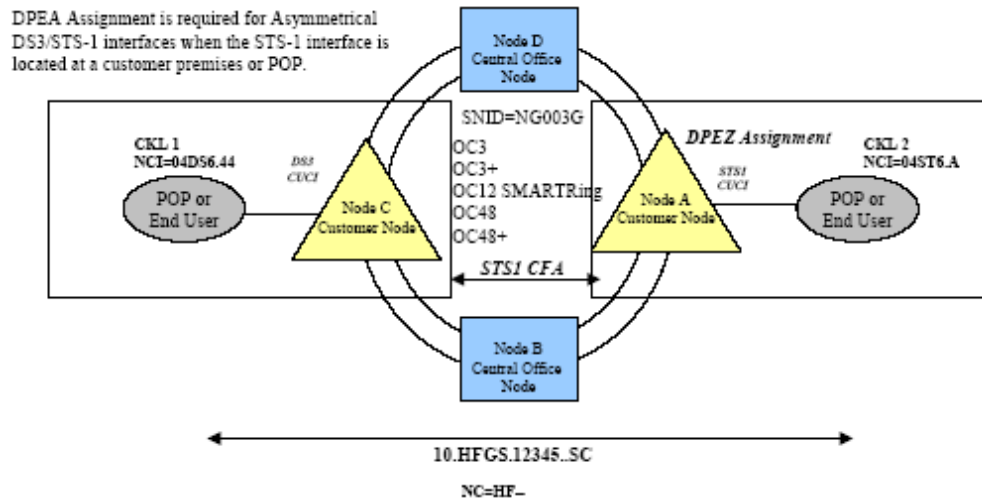

Figure 17. OC3, OC3+, OC12, OC48, OC48+ Drawing 3a

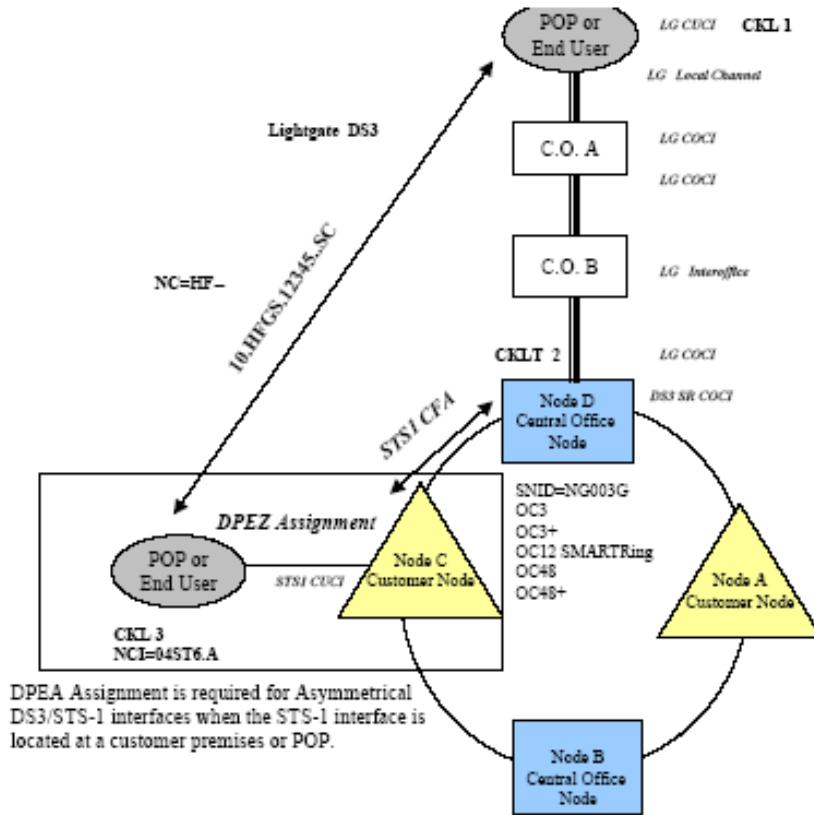
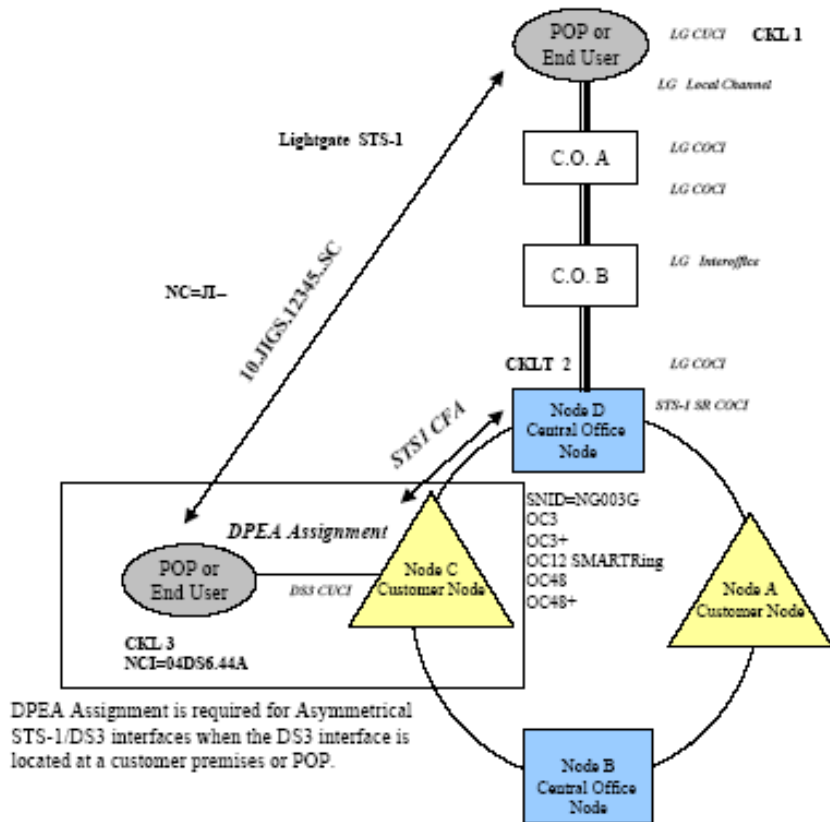

Figure 18. OC3, OC3+, OC12, OC48, OC48+ Drawing 3b



DPEA Assignment is required for Asymmetrical STS-1/DS3 interfaces when the DS3 interface is located at a customer premises or POP.

Figure 19. OC3, OC3+, OC12, OC48, OC48+ Drawing 3c

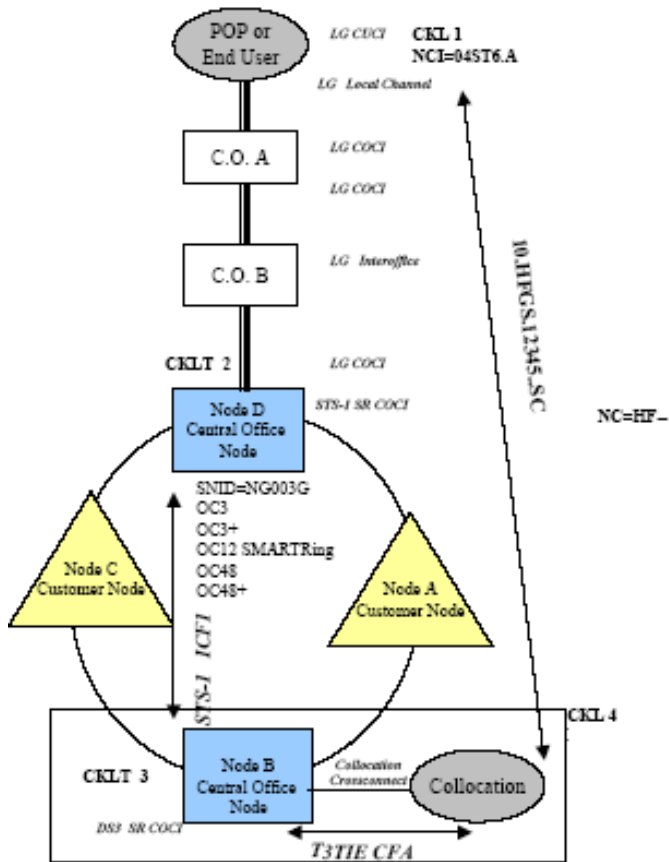

Figure 20. OC3, OC3+, OC12, OC48, OC48+ Drawing 3d

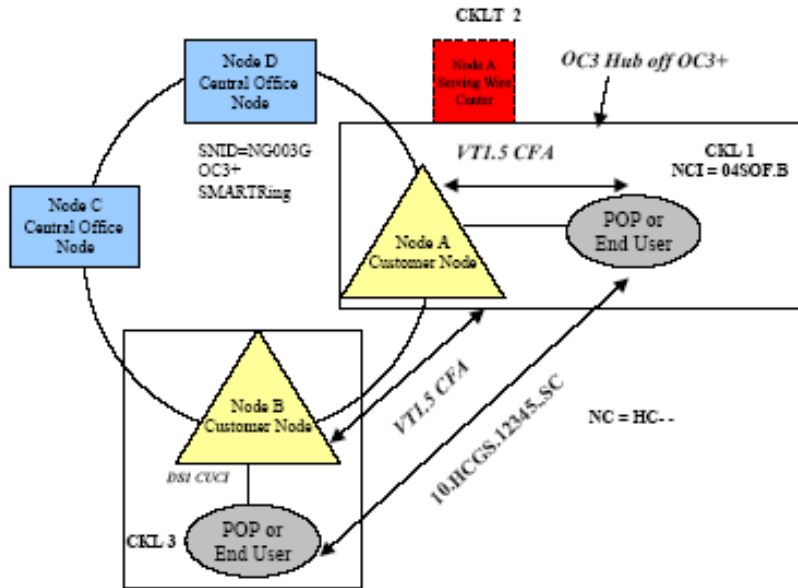

Figure 21. OC3+ SMARTRing Drawing 4b-1

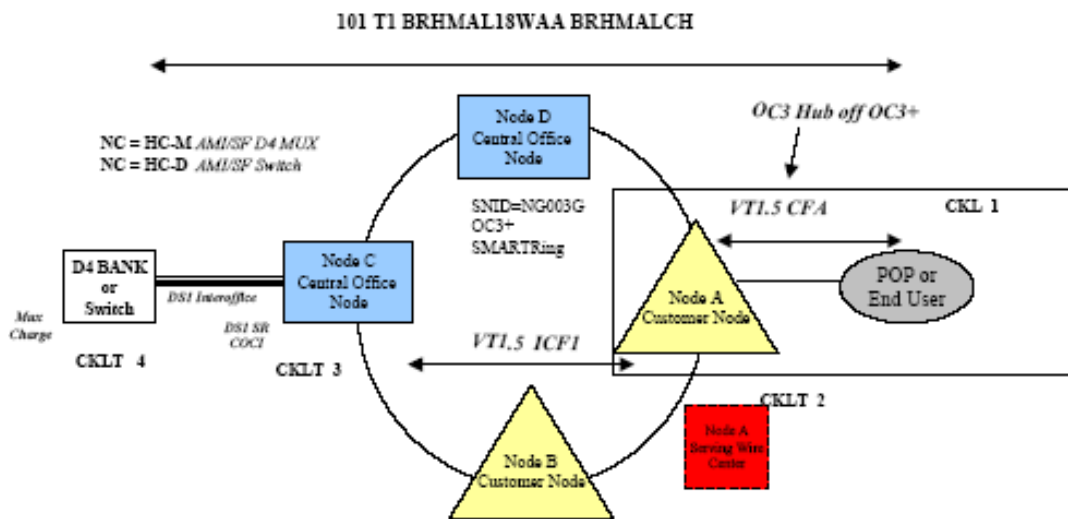

Figure 22. OC3+ SMARTRing Drawing 4b-2

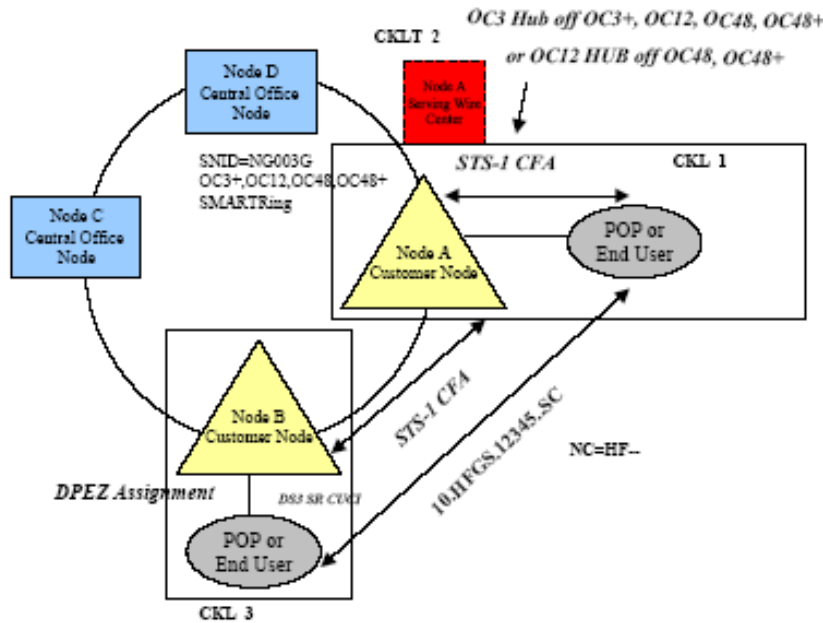

Figure 23. OC3+, OC12, OC48, OC48+ Drawing 4b-3

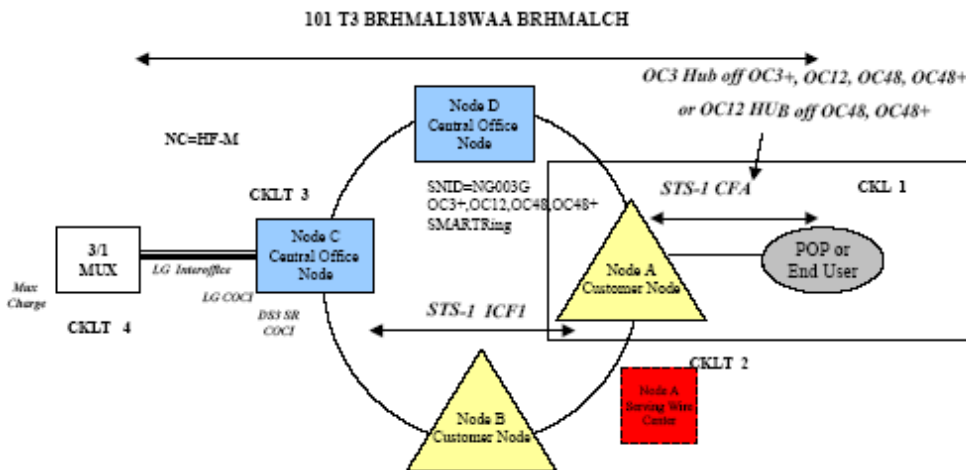

Figure 24. OC3+, OC12, OC48, OC48+ Drawing 4b-4

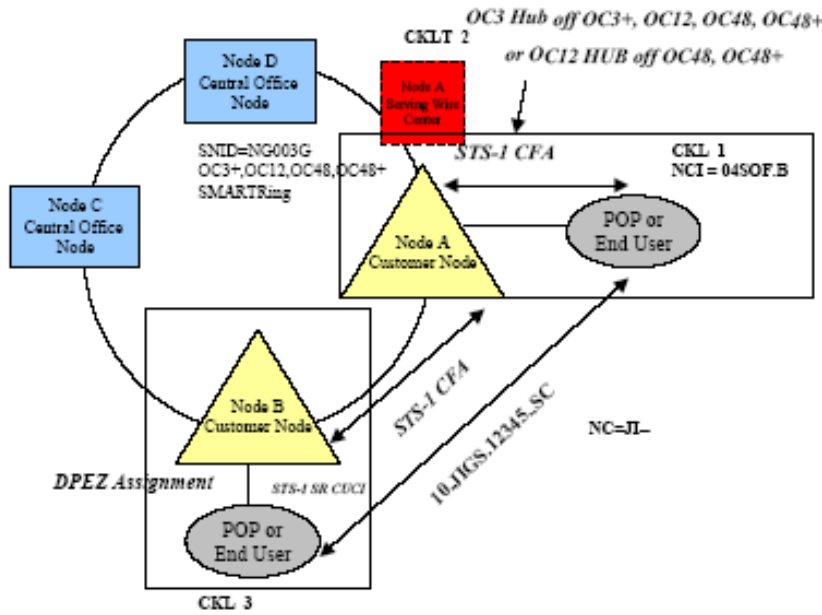

Figure 25. OC3+, OC12, OC48, OC48+ Drawing 4b-5

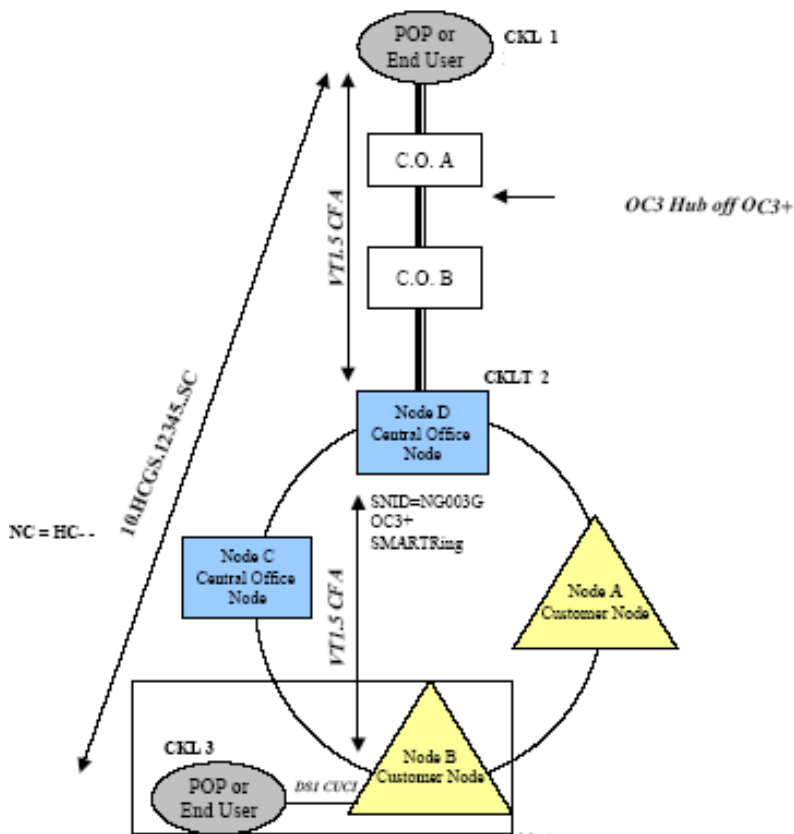

Figure 26. OC3+ SMARTRing Drawing 4b-6



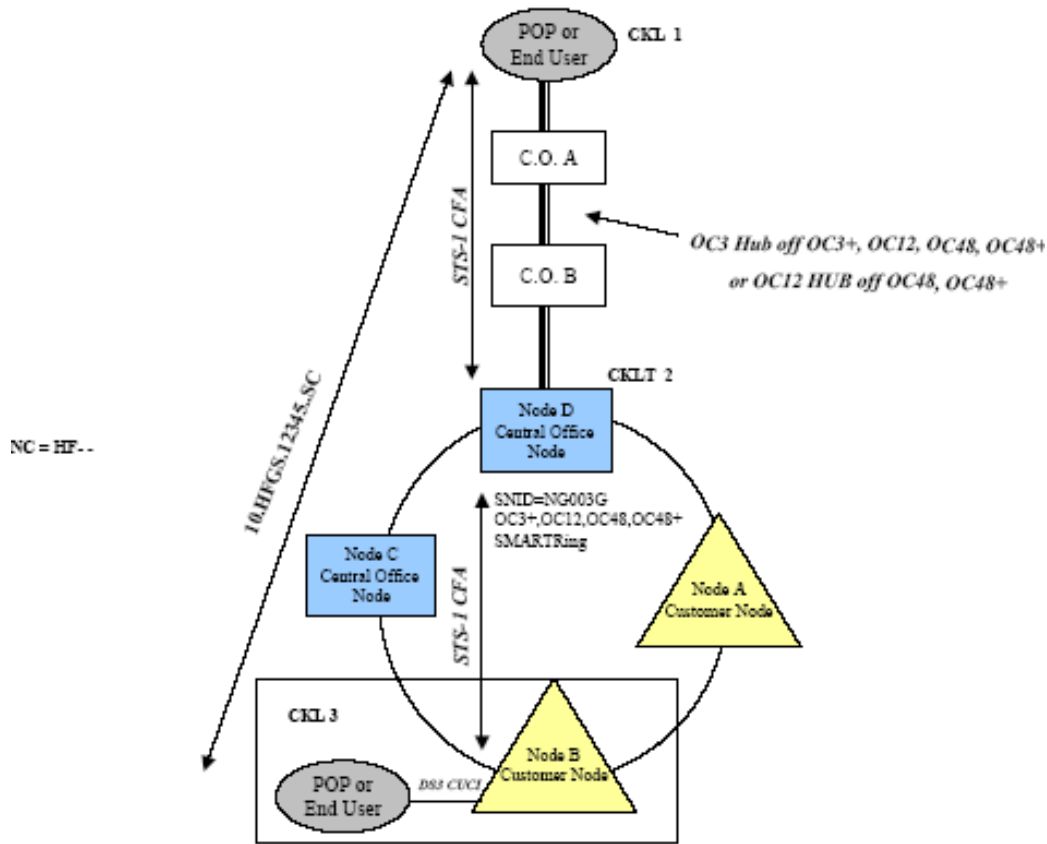

Figure 27. OC+, OC12, OC48, OC48+ SMARTRing Drawing 4b-7

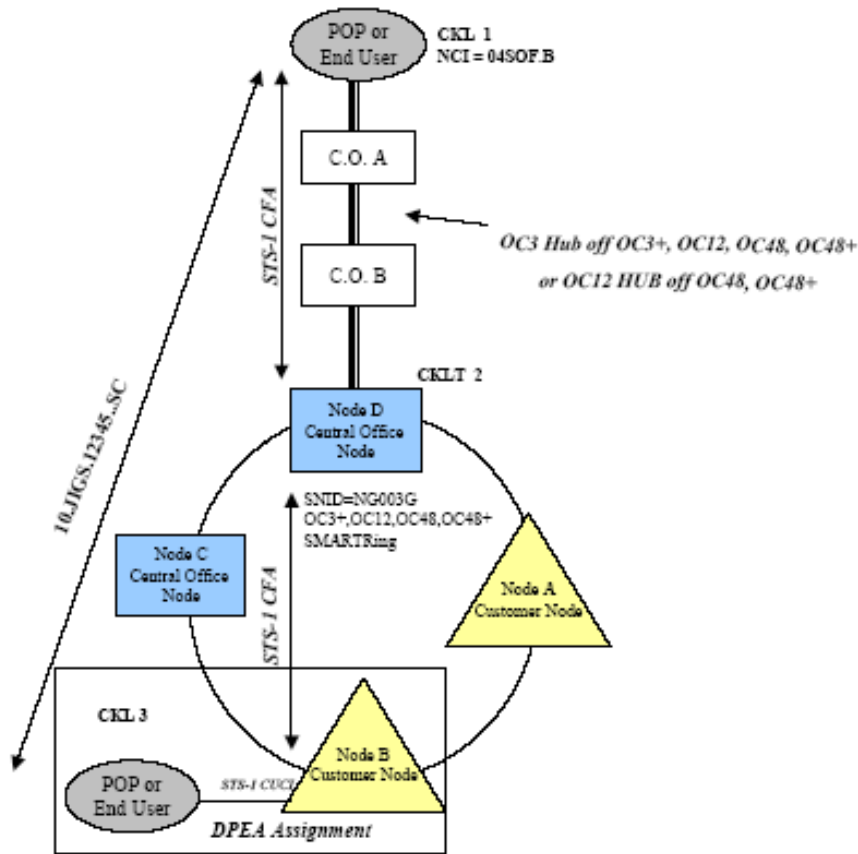

Figure 28. OC+, OC12, OC48, OC48+ SMARTRing Drawing 4b-8

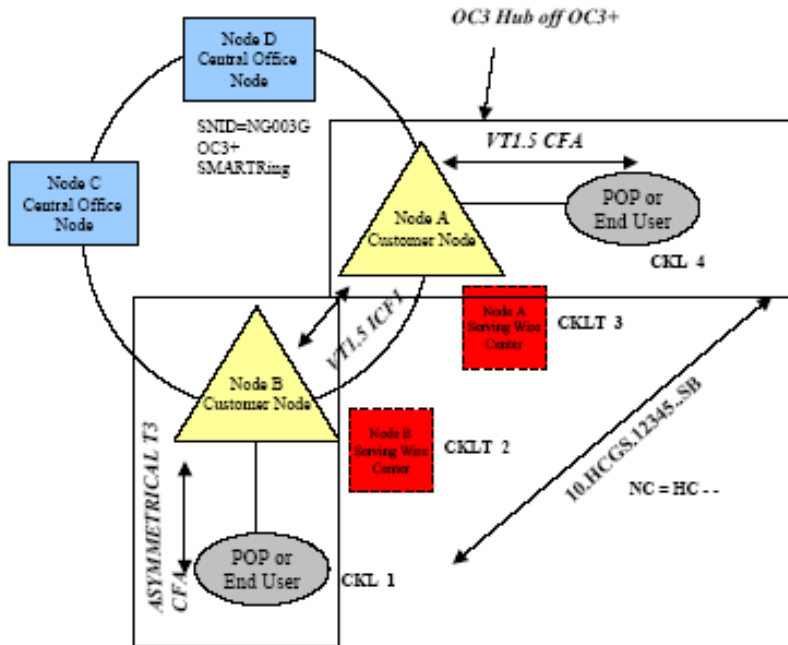

Figure 29. OC+ SMARTRing Drawing 4b-9

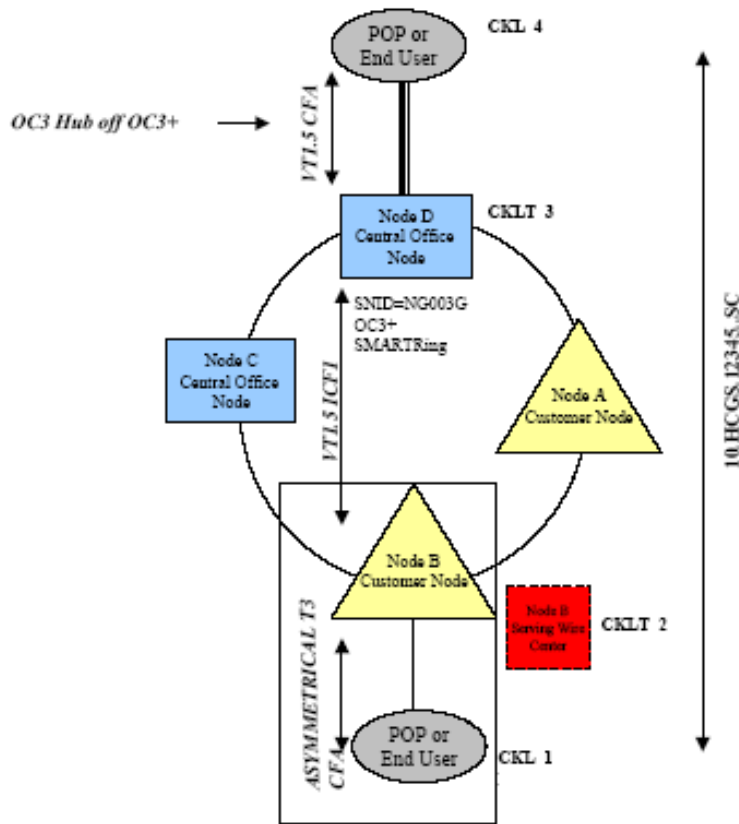

Figure 30. OC3+ SMARTRing Drawing 4b-10

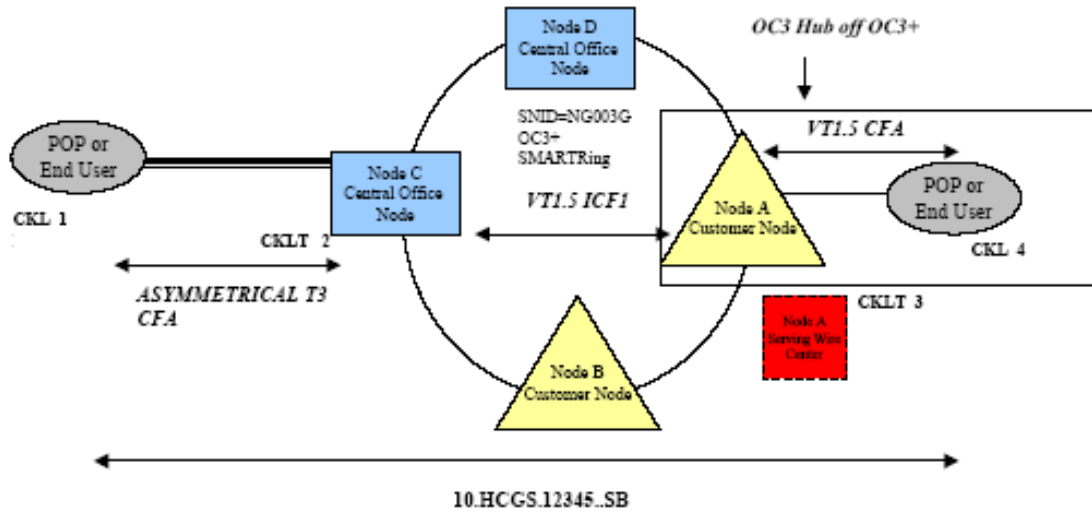

Figure 31. Drawing 4c-1

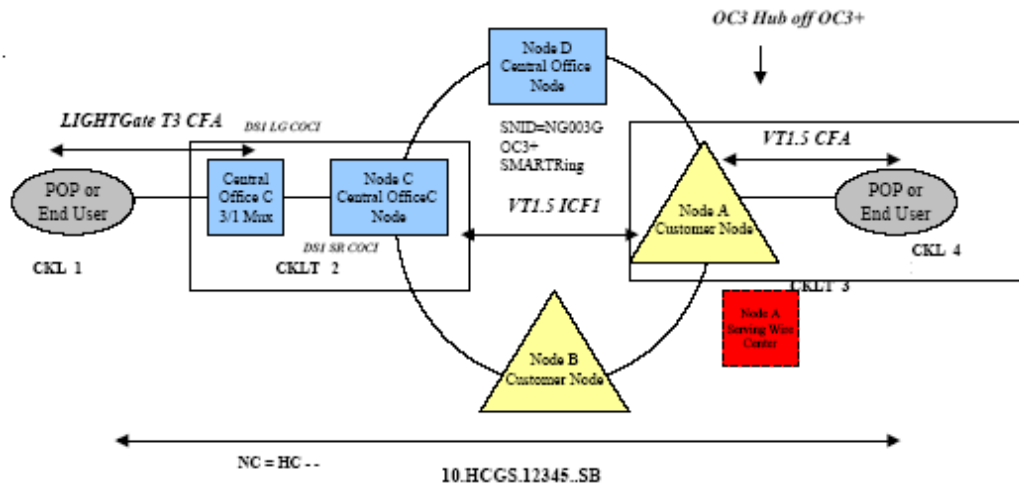

Figure 32. OC3+ SMARTRing Drawing 4c-2

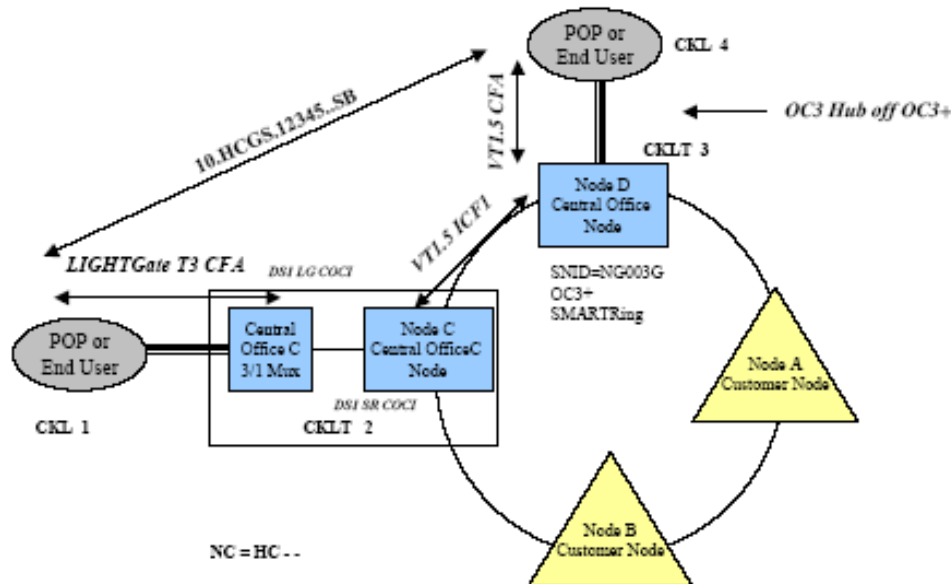

Figure 33. OC3+ SMARTRing Drawing 4c-3

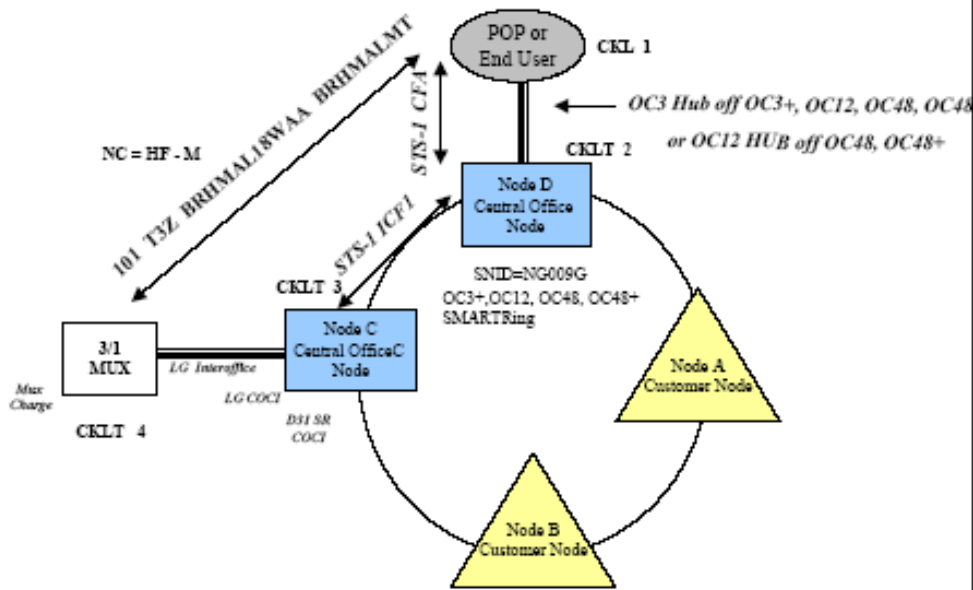

Figure 34. OC3+, OC12, OC48, OC48+ Drawing 4c-4

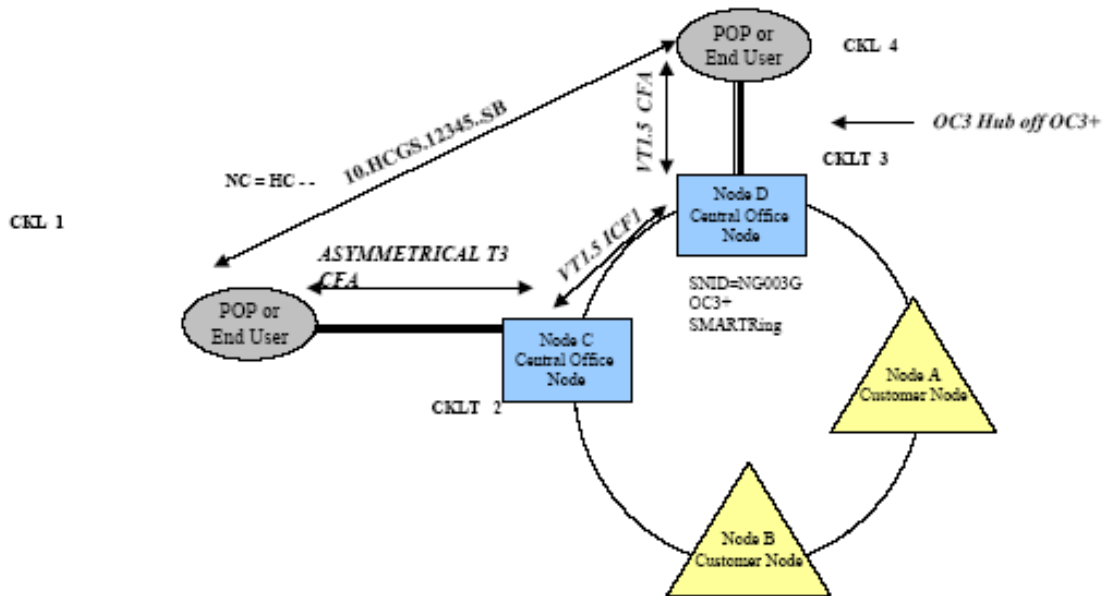

Figure 35. OC3+ SMARTRing Drawing 4c-5

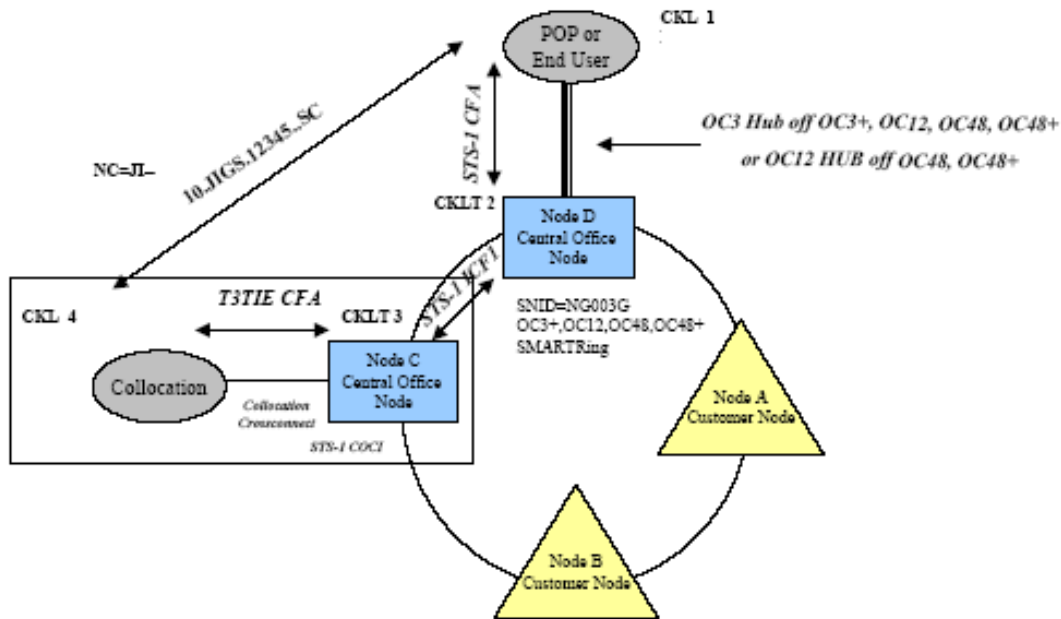

Figure 36. OC3+, OC12, OC48, OC48+ SMARTRing Drawing 4d-3

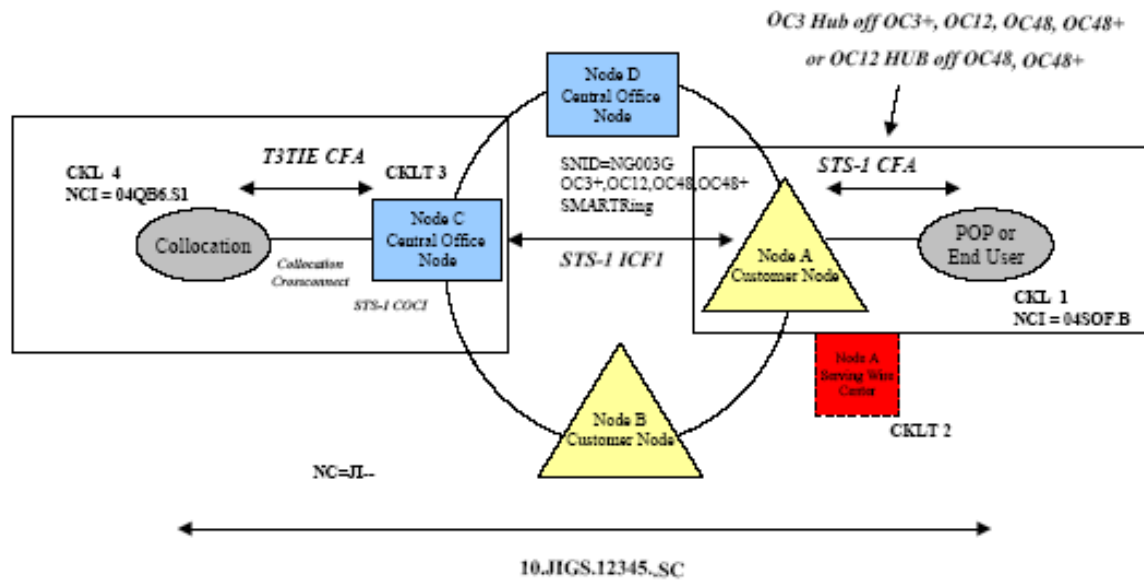

Figure 37. OC3+, OC12, OC48, OC48+ SMARTRing Drawing 4d-4

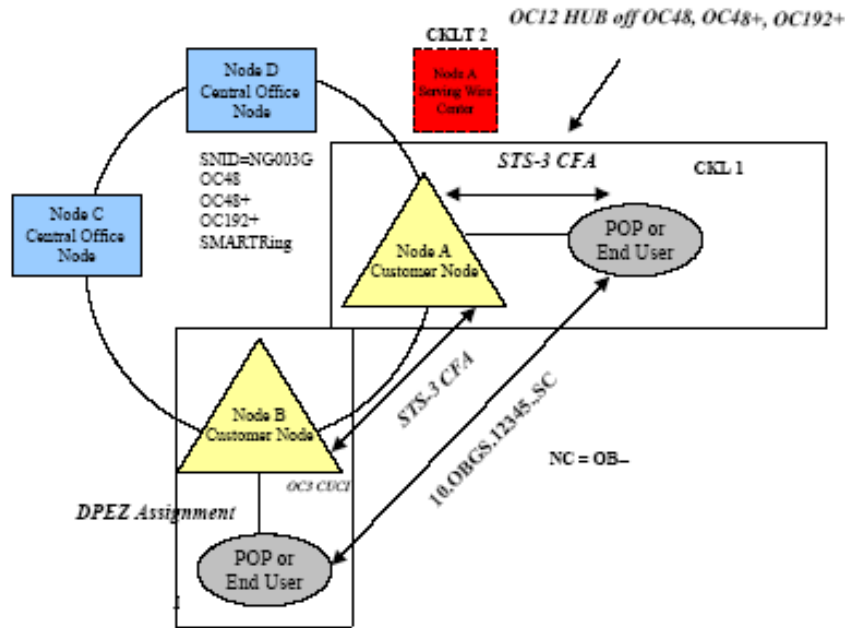

Figure 38. OC48, OC48+, OC192+ SMARTRing Drawing 5a-2

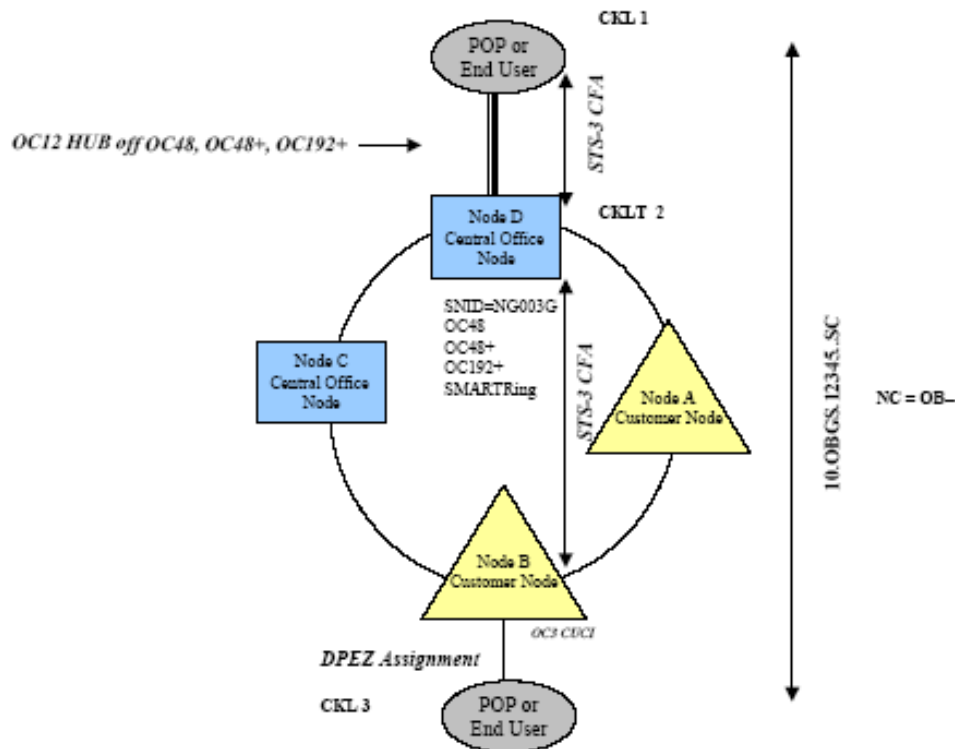

Figure 39. OC48, OC48+, OC192+ SMARTRing Drawing 5b



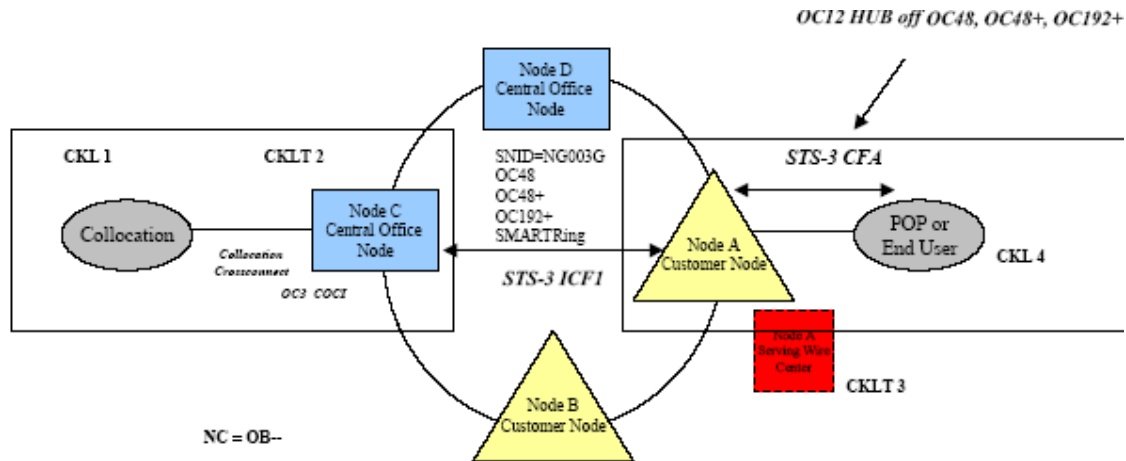

Figure 40. OC48, OC48+, OC192+ SMARTRing Drawing 5c-1

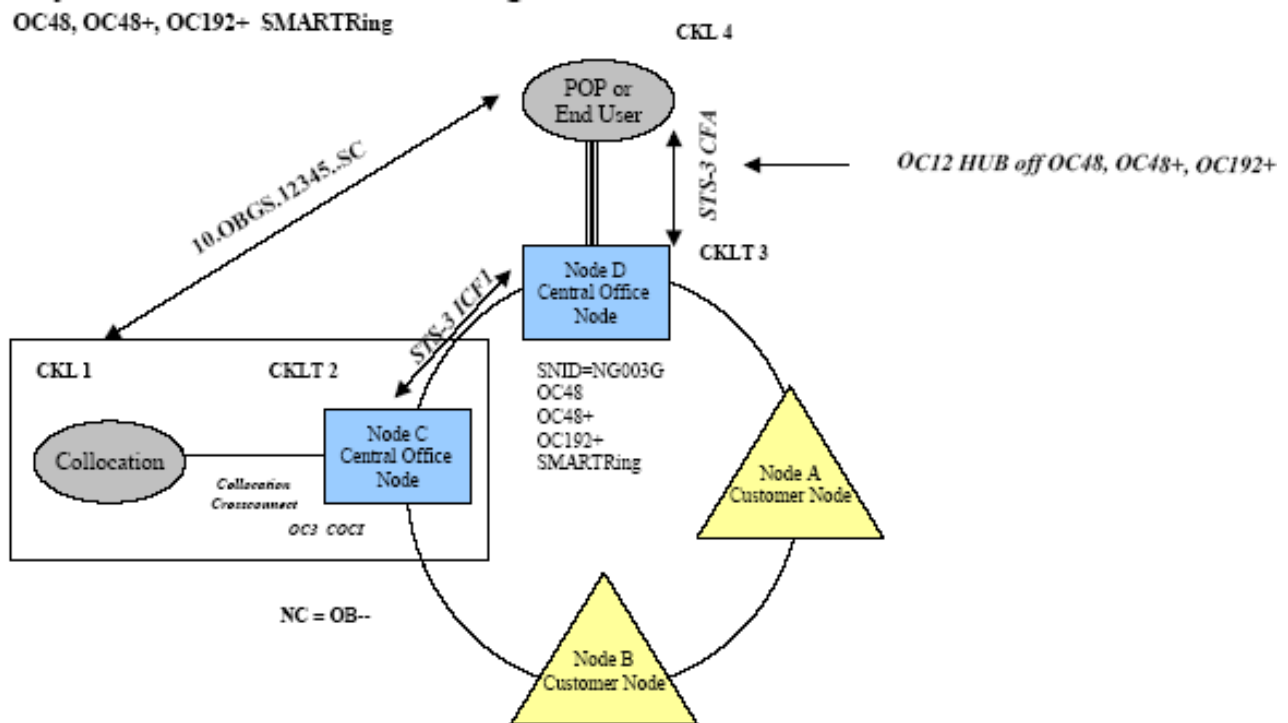

Figure 41. OC48, OC48+, OC192+ SMARTRing Drawing 5c-2

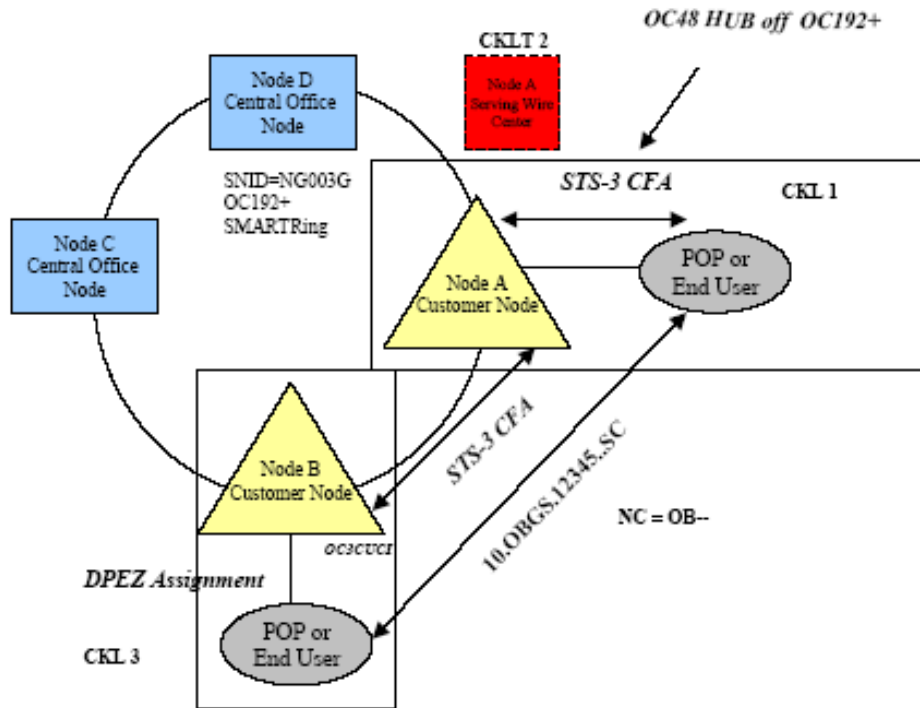

Figure 42. OC192+ SMARTRing Drawing 6a-2

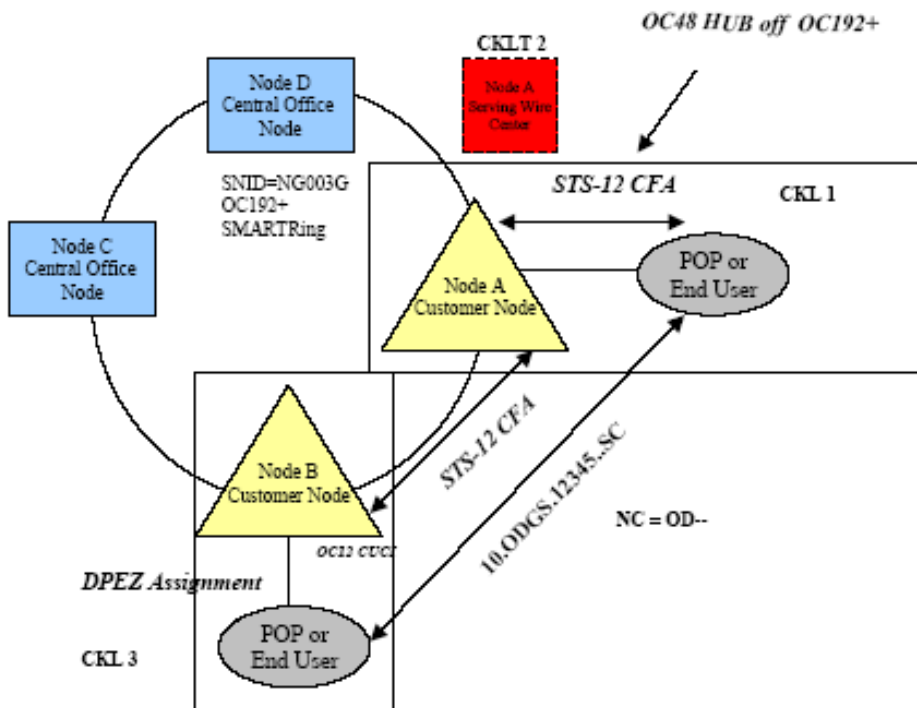

Figure 43. OC192+ SMARTRing Drawing 6a-3

OC192+ SMARTRing

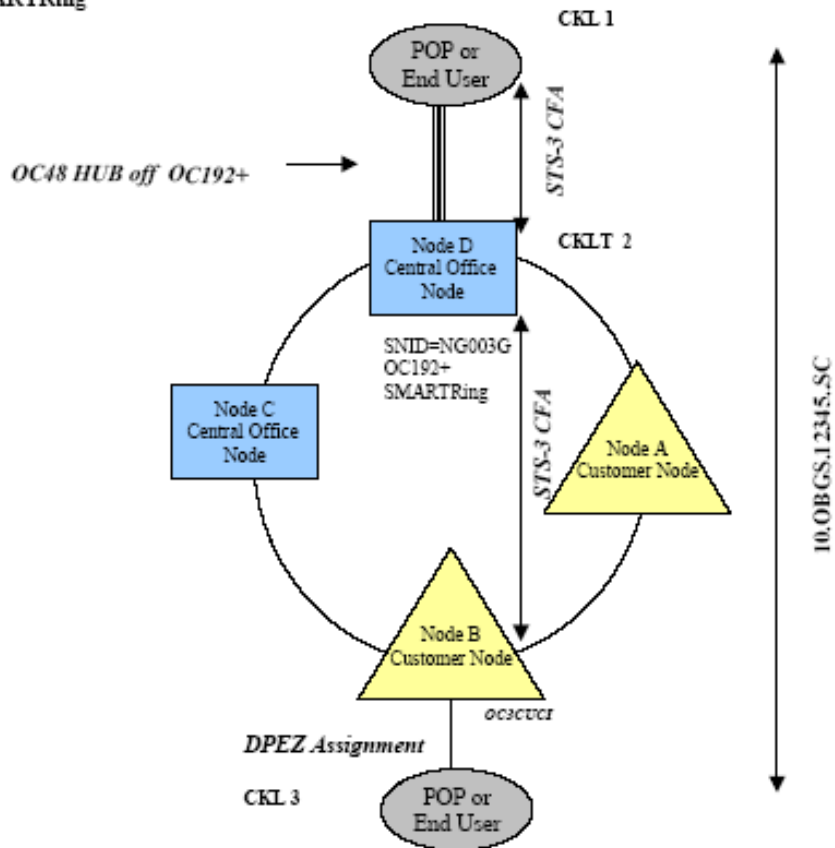

Figure 44. OC192+ SMARTRing Drawing 6b-1

OC192+ SMARTRing

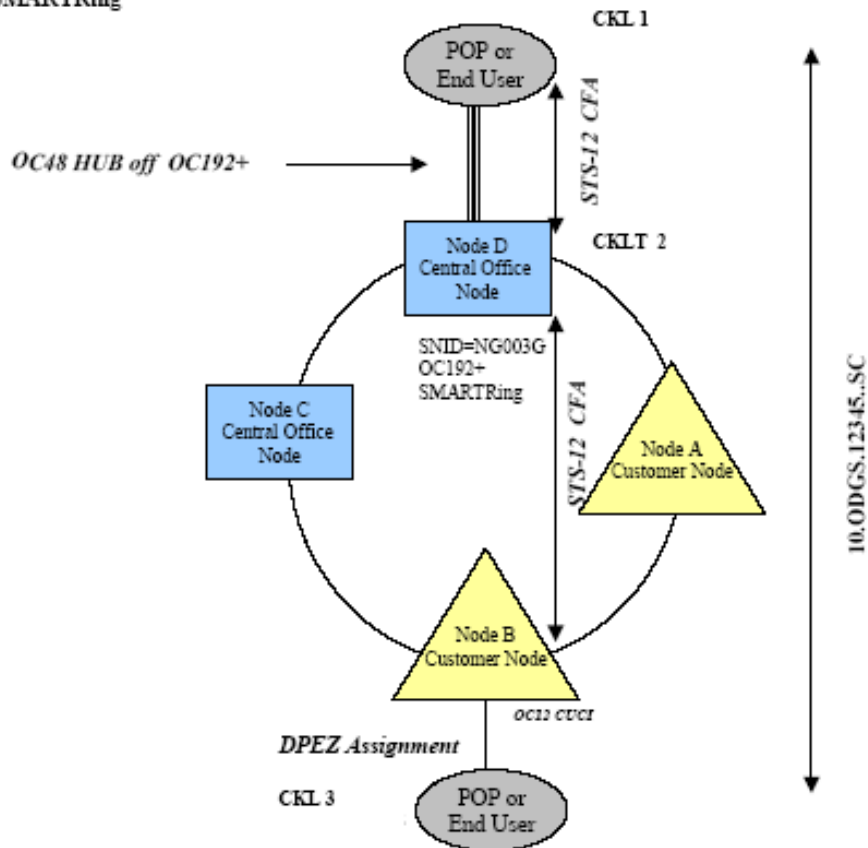

Figure 45. OC192+ SMARTRing Drawing 6b-2

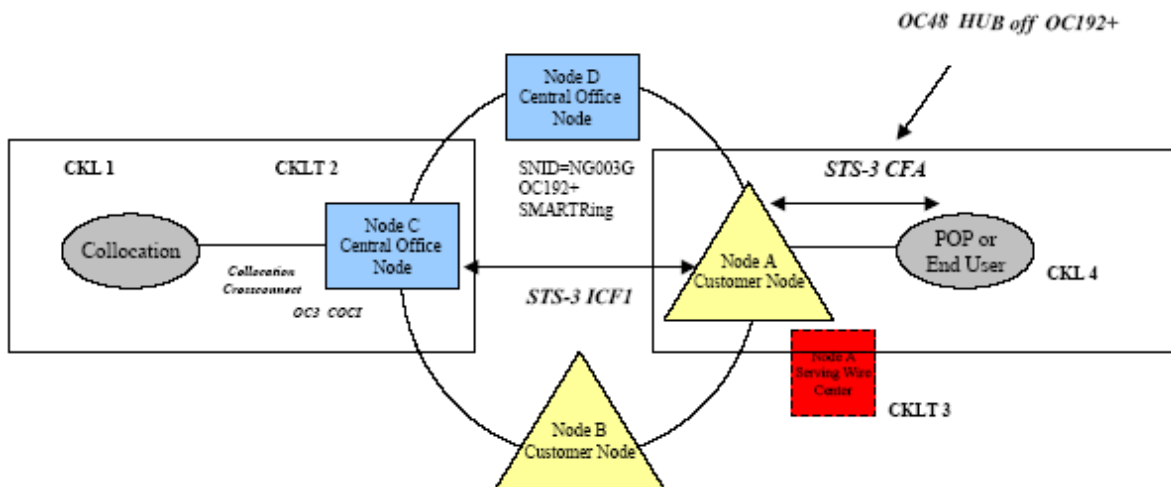

Figure 46. OC 192+ SMARTRing Drawing 6c-1

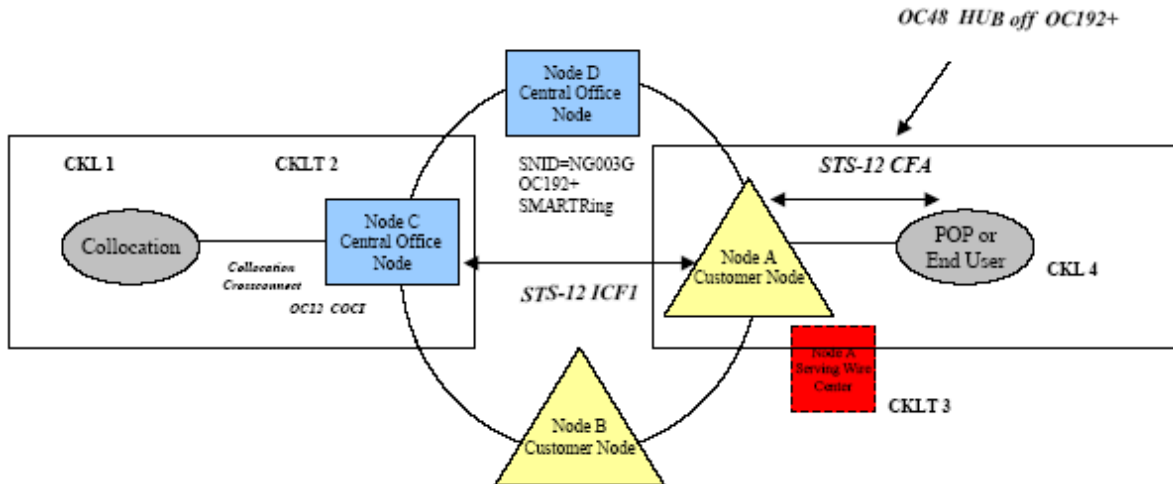

Figure 47. OC192+ SMARTRing Drawing 6c-2

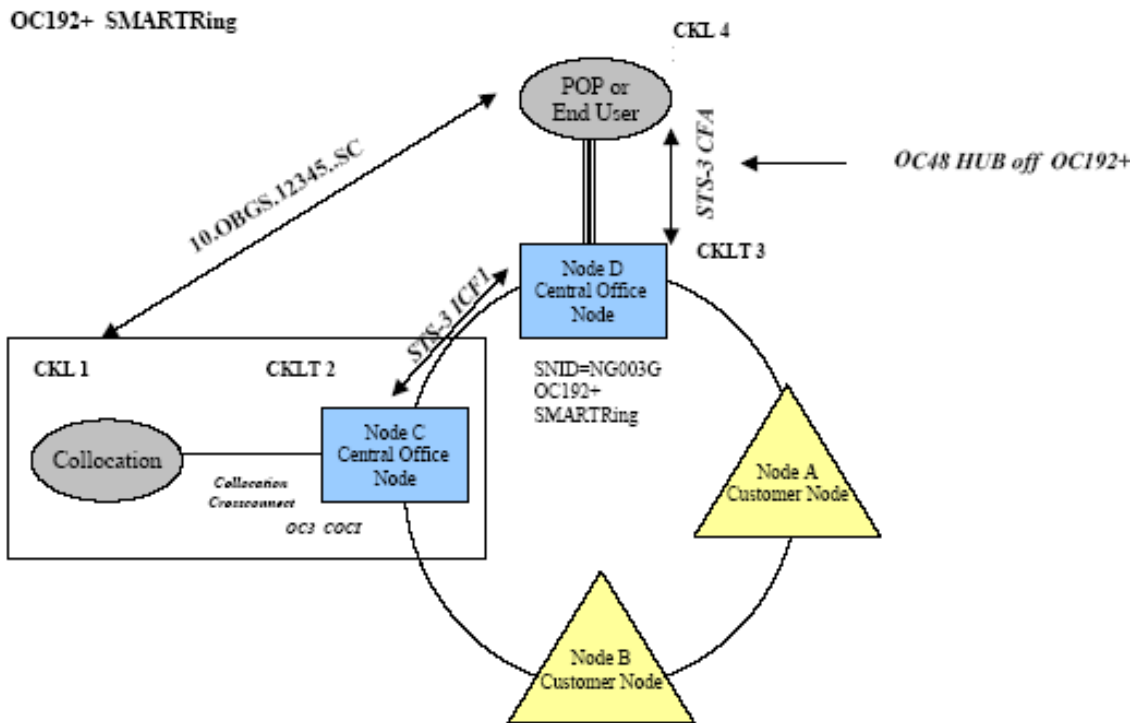

Figure 48. OC192+ SMARTRing Drawing 6c-3

OC192+ SMARTRing

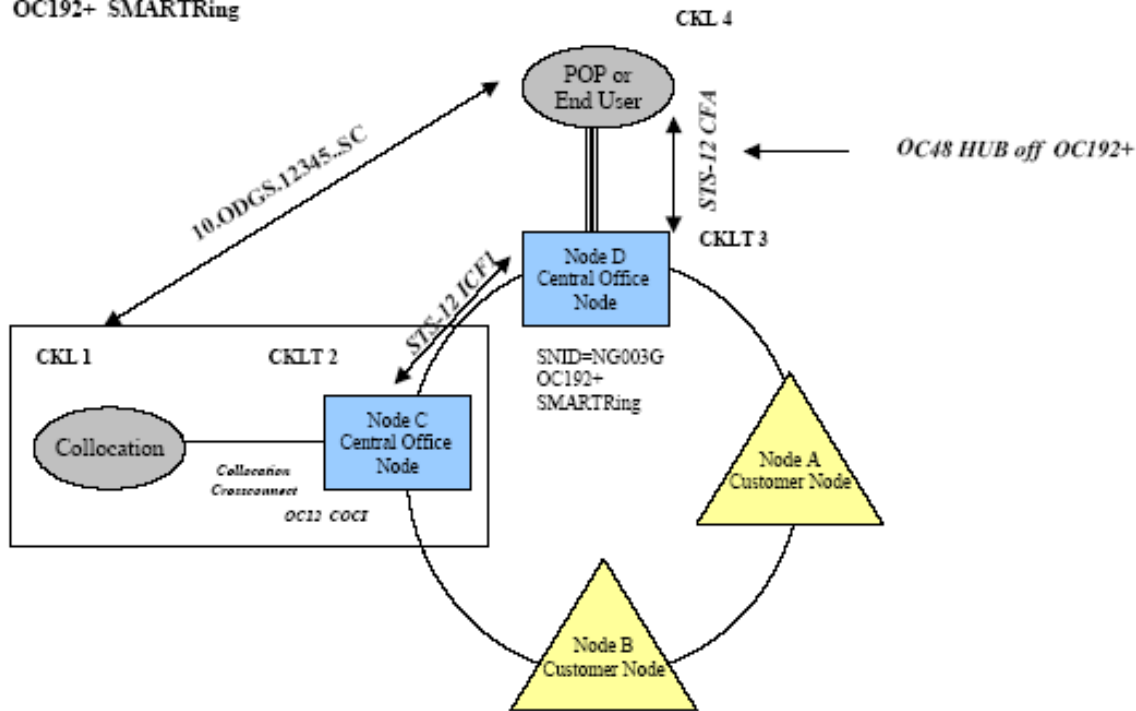

Figure 49. OC 192+ SMARTRing Drawing 6c-4

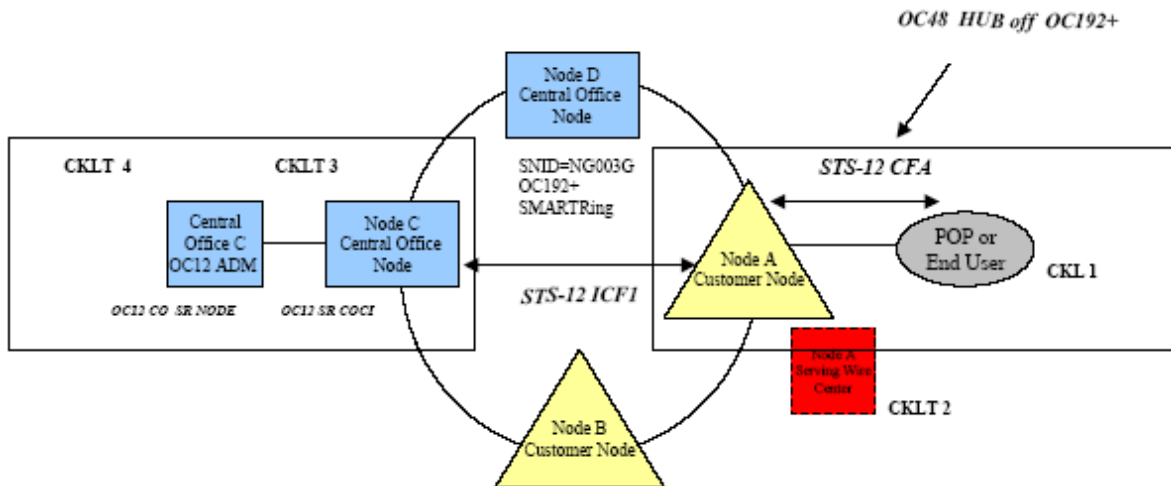

Figure 50. OC192+ SMARTRing Drawing 6c-5

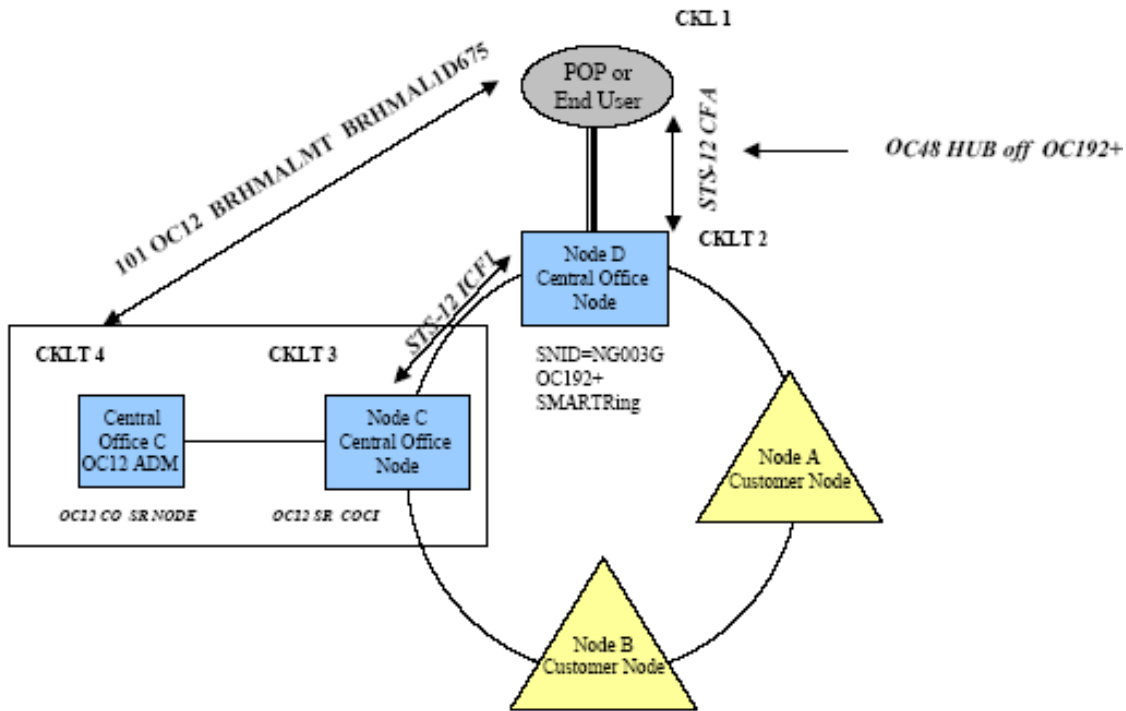

Figure 51. OC192+ SMARTRing Drawing 6c-6